

# Technical Data Manual

Model Nos. and pricing: see Price List

**Nu-Air HA Series**  
Hydronic forced air handler

## Nu-Air HA Series



### **Nu-Air**

HA Series, Models 6018, 8524 and 9836

The Nu-Air HA works directly with other hot water sources to provide warm comfortable heating for any home or small commercial building.



**Intertek**

104131/06TOR-001  
Conforms to UL Std 1995  
Certified to C236vClause 3.3

## Nu-Air HA Series

The Nu-Air HA Series is engineered to be used with hydronic (boiler) systems. Outputs range from 25 MBH to 102 MBH.

### The benefits at a glance:

- **Total Comfort:** Delivers warm comfortable conditioned air, warmer than heat pumps and many furnaces.
- **Quiet performance:** Engineered and balanced with extra insulation for quiet operation.
- **Dependable:** Manufactured to precise specifications, using high performance components.
- **Accessories:** Prewired for heating, cooling, and electronic air cleaners.
- **Multi-position:** Unit mounts in any direction - upflow, downflow or horizontal discharge right or left. External filter rack for other return air options (included).
- **Cooling:** Pre-wired for A/C. Just add your favorite evaporator coil and condensing unit from most manufacturers.
- **Protection:** Built-in safety sensors provide whole house freeze protection, in case of thermostat failure.
- All designs include filter rack.
- All models are compatible with standard or digital thermostats.

## Components

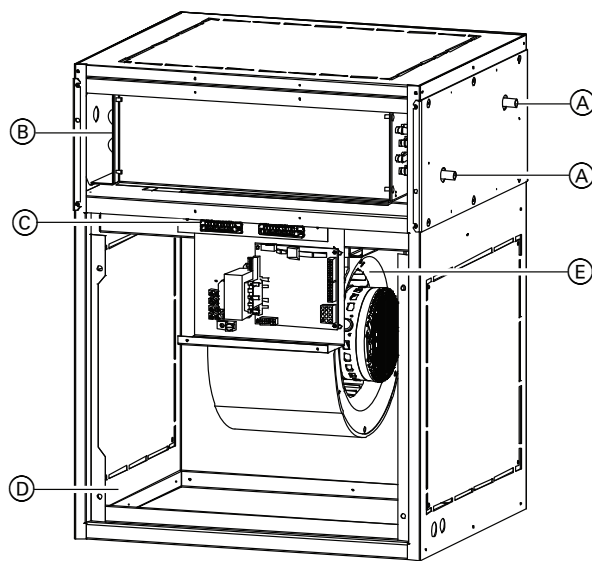

### Legend

- (A) Hydronic supply/return connections
- (B) Heating coil
- (C) Connections for up to 3 thermostats (for 3 zones and outputs for 3 zone dampers)
- (D) Acoustic sound reduction insulation.
- (E) Blower motor and controls

### Cabinet

All cabinets have a tough, durable powder coat finish on heavy gauge aluminum.

### Heating coils

All heating coils are copper and assembled using no lead solder. High density aluminum fins provide maximum heat transfer for small coil surface.

### Fan and motor

Constant speed EC (Electronically Commutated) Motor.

### Pump exercise function

Pump terminals, 120VAC. Controlled by the HA including 24 hr. pump exerciser to eliminate stagnant water.

### Zone control logic

Integrated zone control to control up to 3 zones. Zone 1 lead logic prevents simultaneous heat and cool calls.

## Technical Data

	Description	HA 6018	HA 8524	HA 9836
Motor (ECM)	hp	1/2	1/2	3/4
Motor rated amps - loaded	AMPS	6.1	6.1	9.2
Electrical	VOLTS/PH/HZ	120/1/60	120/1/60	120/1/60
Heating BTUH (kW)	120°F (49°C)	25,000 (7.4)	34,000 (10.0)	44,000 (13.0)
	140°F (60°C)	35,000 (10.3)	49,000 (14.4)	63,000 (18.5)
	160°F (71°C)	46,000 (13.5)	63,000 (18.5)	83,000 (24.4)
	180°F (82°C)	56,000 (16.4)	78,000 (23.0)	102,000 (30.0)
Flow	USG/min (L/H)	5 (1135)	7 (1590)	7 (1590)
Nominal Air Flow	CFM	700	900	1,200
Cooling capacity	(tons)	1 to 2	2 to 2.5	2 to 3
Cabinet	D x W x H in. (mm)	19 1/4 X 22 3/4 X 29 (487 X 575 X 737)	21 1/4 X 22 3/4 X 31 1/2 (539 X 575 X 800)	21 1/4 X 22 3/4 X 31 1/2 (539 X 575 X 800)
Air Filter Size (Field Supplied)	in.	16 X 16	20 X 20	20 X 20
Supply air opening	in. (mm)	16 x 20 (406 x 508)	20 x 20 (508 x 508)	20 x 20 (508 x 508)
Return air opening	in. (mm)	14 x 14 (356 x 356)	18 x 18 (457 x 457)	18 x 18 (457 x 457)
Weight	lb.	76	93	94
	kg	35	42	43
<b>Hydronic heating coil</b>				
Construction	Copper tubing, aluminum fins, galvanized steel support frame			
Rows...fins/in.		4/16	4/16	4/16
Total face area	sq. ft. (m <sup>2</sup> )	1.5 (0.14)	2.3 (0.21)	2.3 (0.21)
<b>Piping connections</b>				
Supply	in.	1/2 (Sweat)	3/4 (Sweat)	3/4 (Sweat)
Return	in.	1/2 (Sweat)	3/4 (Sweat)	3/4 (Sweat)
Pressure drop through the coil	feet of head [@ 140°F (60°C)]	4.1	3.6	3.6

### Permissible ambient temperature

Installation in living spaces or boiler rooms (standard ambient conditions);

- During operation 32 to 104°F (0 to +40°C)
- During storage and transport -4 to 149°F (-20 to +65°C)

# Dimensions

## IMPORTANT

The maximum ambient temperature must not exceed 104°F (40°C).

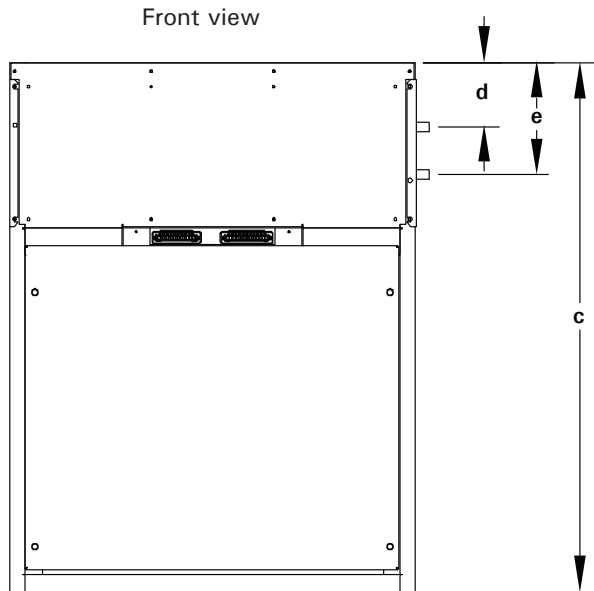
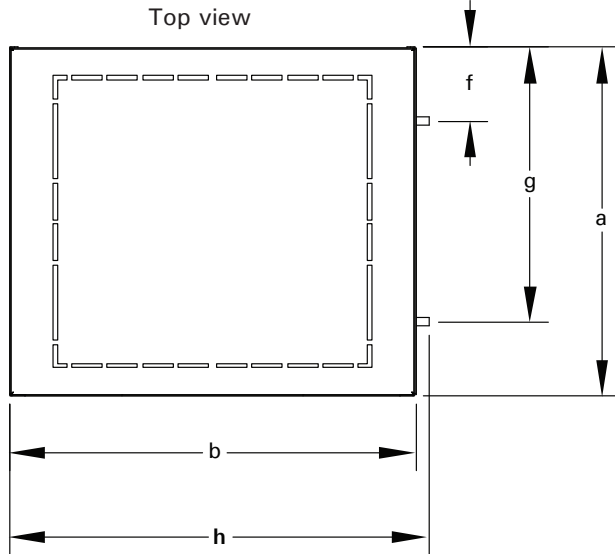

		HA 6018	HA 8524	HA 9836
a	in. (mm)	19¼ (487)	21¼ (539)	21¼ (539)
b	in. (mm)	22¾ (575)	22¾ (575)	22¾ (575)
c	in. (mm)	29 (737)	31½ (800)	31½ (800)
d	in. (mm)	3½ (89)	3¾ (93)	3¾ (93)
e	in. (mm)	6¼ (156)	6¼ (160)	6¼ (160)
f	in. (mm)	4¼ (104)	2¼ (53)	2¼ (53)
g	in. (mm)	15¼ (383)	19¼ (485)	19¼ (485)
h	in. (mm)	23¾ (600)	23¾ (603)	23¾ (603)

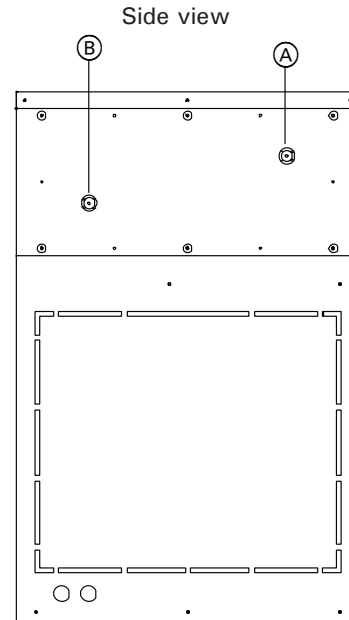

### Legend

- (A) Hydronic supply connection
- (B) Hydronic return connection

## Minimum Clearances

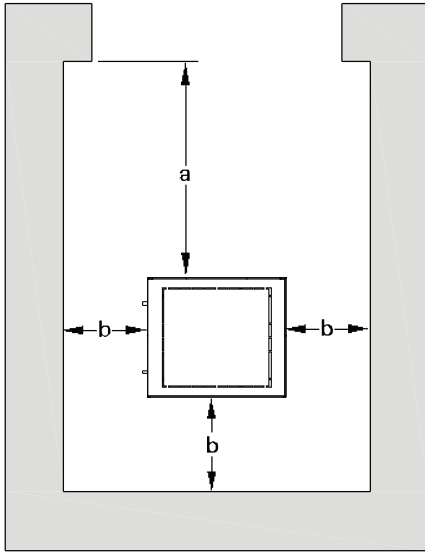

### Recommended minimum service clearances

For typical Nu-Air HA installation, it is recommended to install the air handler with the clearances shown in the illustration.

- a - 24 in. (610 mm)
- b - 0 in. (0 mm)

These dimensions reflect the recommended service clearance for the air handler only, ensure adequate clearance is left for the installation of ducting, piping and electrical connections. Ensure to leave adequate clearance for ductwork, plumbing and electrical connections, with zero clearance between the air handler unit and ducting being acceptable.

The Nu-Air HA requires 0 in. (0 mm) clearance to combustibles.

## Heating Circuit Pumps

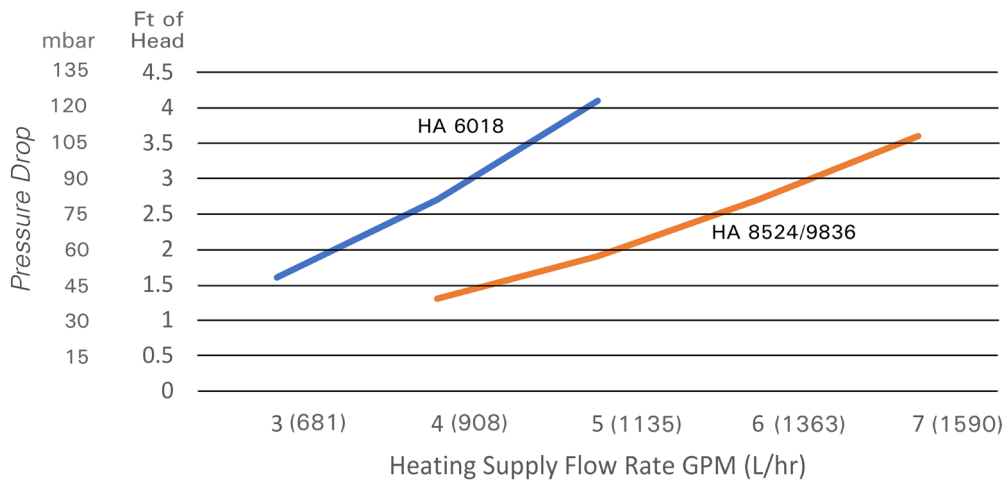

Flow Rate GPM (L/h)	3 (681)	4 (908)	5 (1135)	7 (1590)
Pressure Drop HA 6018 Ft of Head (mbar)	1.6 (48)	2.7 (81)	4.1 (123)	--
Pressure Drop HA 8524 / 9836 Ft of Head (mbar)	--	1.3 (39)	1.9 (57)	3.6 (108)

# Electrical Connections

**WARNING**  
**DISCONNECT POWER BEFORE SERVICING AIR HANDLER.**

If any of the original wires as supplied with the appliance must be replaced, it must be replaced with the exact equivalent.

**CAUTION**  
 Label all wires prior to disconnection when servicing controls. Wiring errors can cause improper and dangerous operation. Verify proper operation after servicing.

## Field Connections

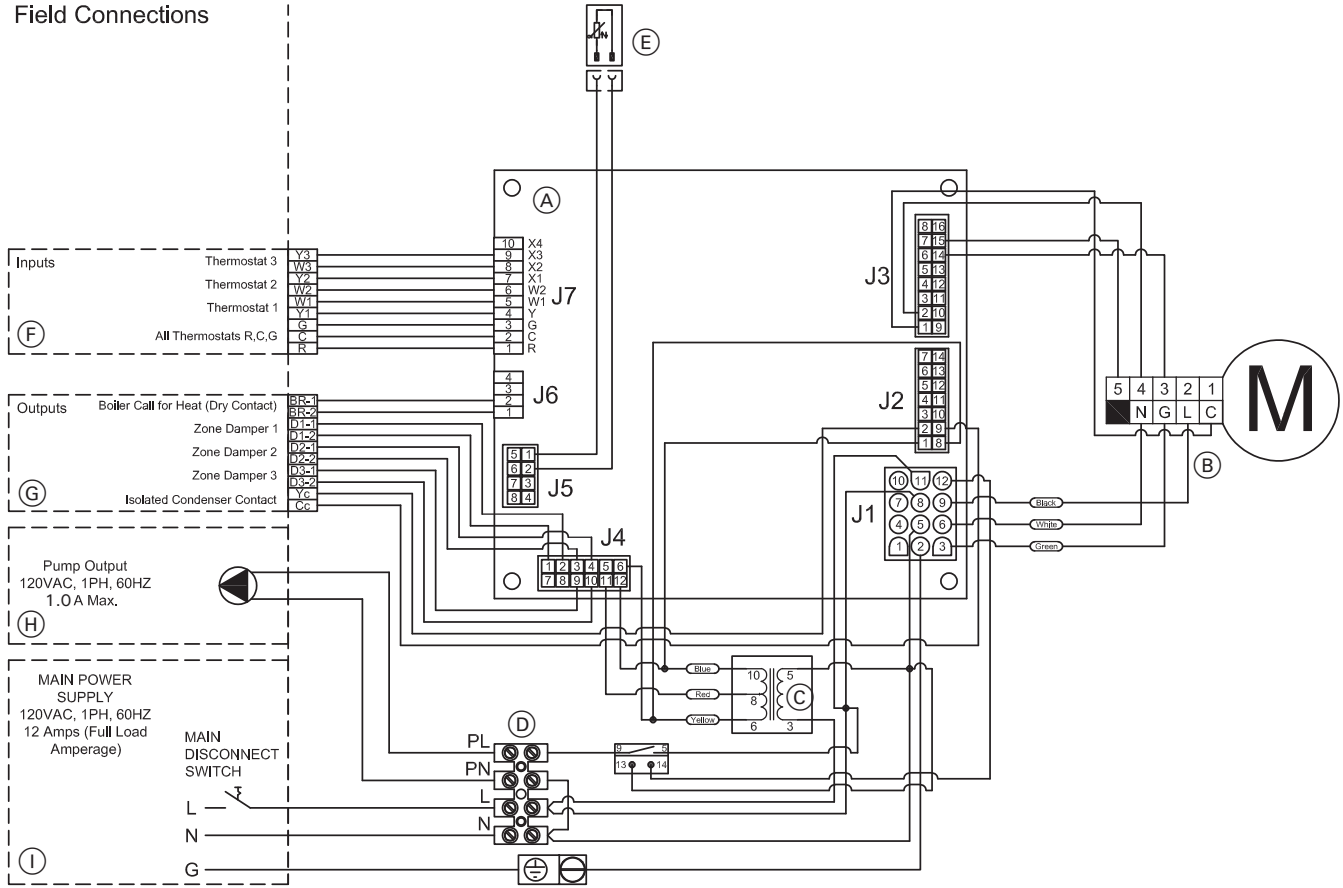

### Legend

- (A) Nu-Air HA control panel
- (B) EC blower motor
- (C) 24VAC transformer
- (D) 120VAC connections
- (E) Coil temperature sensor
- (F) Thermostat inputs
- (G) Call for heat, damper, and condenser outputs
- (H) Nu-Air HA pump output (120VAC, 1.0A)
- (I) Nu-Air HA power supply (120VAC/1/60, 12 FLA)

# System Layout 1

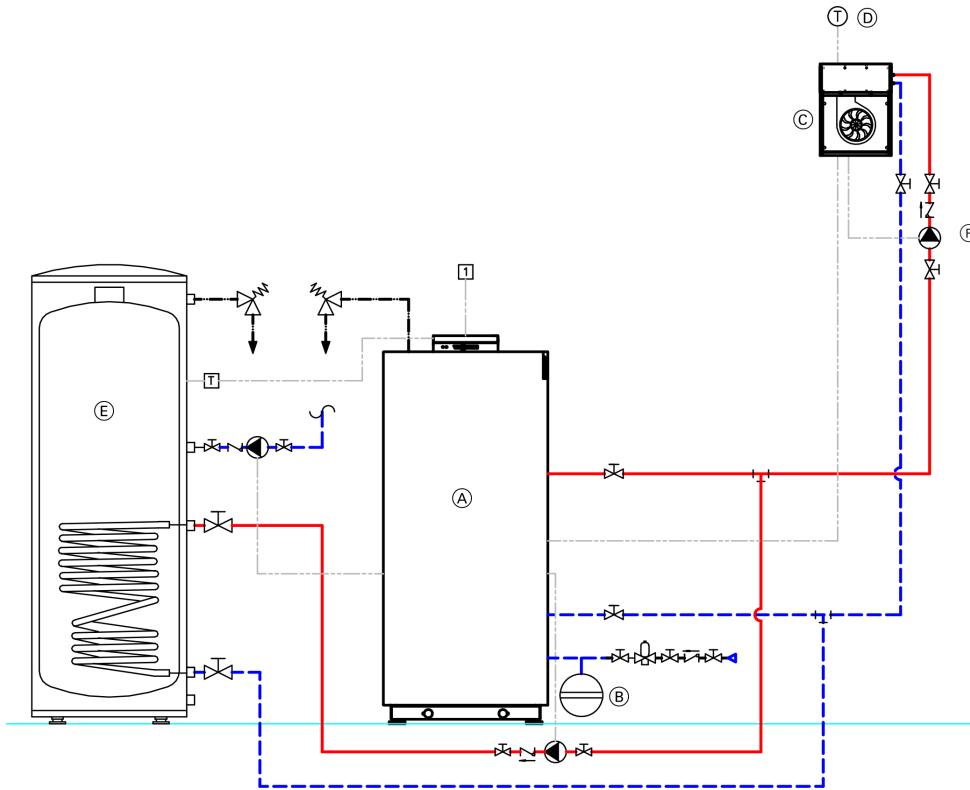

**Legend**

- Ⓐ Viessmann Vitocrossal 300 CU3A high mass boiler
- Ⓑ System fill with expansion tank
- Ⓒ Nu-Air HA air handler
- Ⓓ Thermostat (field supplied)
- Ⓔ Indirect fired DHW storage tank
- Ⓕ Air handler pump

**Note:** System layout is for concept purposes only.

**IMPORTANT**

Please note location of expansion tank.  
 Sizing of field-supplied pumps are critical for proper boiler operation in this system layout. An undersized pump may cause short-cycling and/or improper operation of the boiler.



Refer to the boiler Installation Instructions for additional information.

## System Layout 2

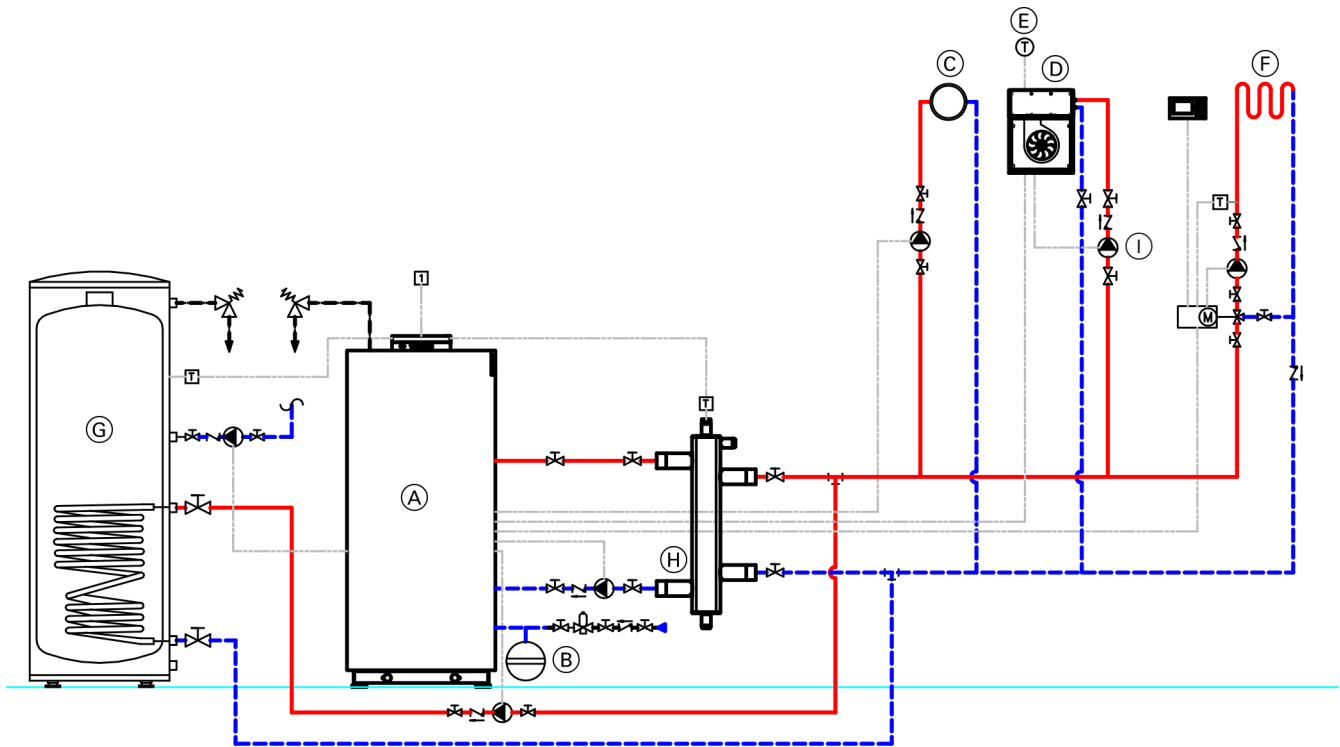

### Legend

- (A) Viessmann Vitocrossal 300 CU3A high mass boiler
- (B) System fill with expansion tank
- (C) High temperature heating loop
- (D) Nu-Air HA air handler
- (E) Thermostat (field supplied)
- (F) Low temperature heating loop with mixing valve
- (G) Indirect fired DHW storage tank
- (H) Low loss header (or closely spaced tees)
- (I) Air handler pump

**Note:** System layout is for concept purposes only.

### IMPORTANT

The use of a low-loss header (or closely spaced tees with a maximum spacing of 4X pipe diameter) is strongly recommended if the maximum water flow rate in the application concerned exceeds the maximum or minimum flow rates of the boiler or if the system flow rates are unknown.

The low-loss header is available as accessory part.

Please note location of expansion tank.

System separation is required of underfloor heating systems employing non-oxygen diffusion barrier tubing. All components on the secondary side of the heat exchanger must be made of corrosion-resistant materials.

The 3-way mixing valve, built-in to achieve the low temperature level of the under floor heating circuit, is controlled by an accessory kit for a heating circuit with mixing valve.



Refer to the boiler Installation Instructions for additional information.



## System Layout 3

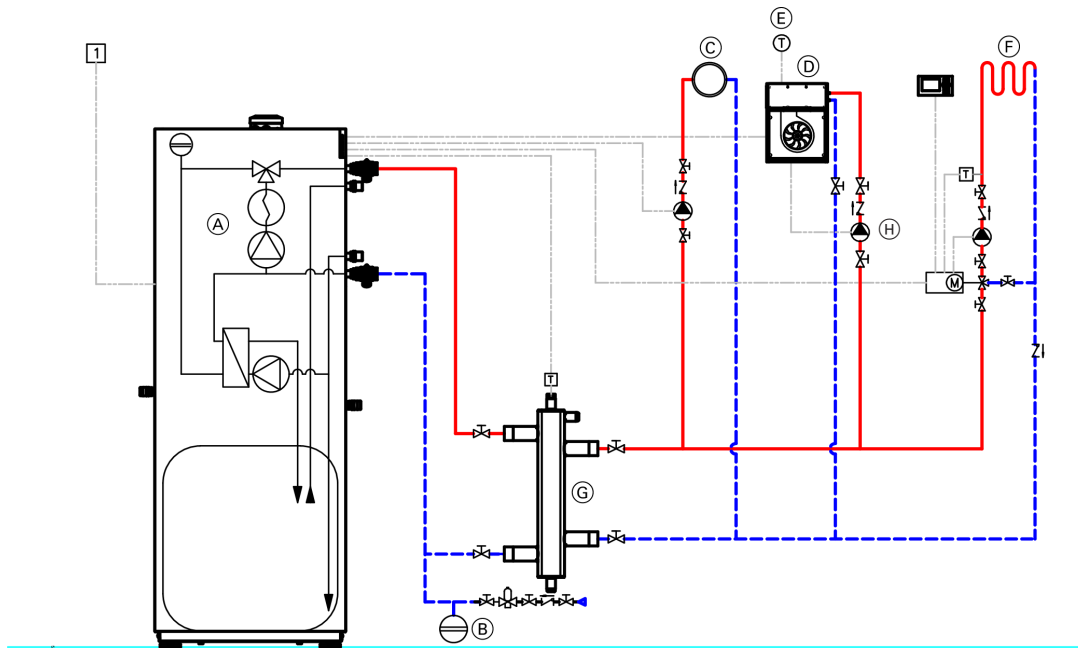

### Legend

- (A) Viessmann Vitodens 222-F B2TA/B boilers
- (B) System fill with expansion tank
- (C) High temperature heating loop
- (D) Nu-Air HA air handler
- (E) Thermostat (field supplied)
- (F) Low temperature heating loop with mixing valve
- (G) Low loss header (or closely spaced tees)
- (H) Air handler pump

**Note:** System layout is for concept purposes only.

### IMPORTANT

The use of a low-loss header (or closely spaced tees with a maximum spacing of 4X pipe diameter) is strongly recommended if the maximum water flow rate in the application concerned exceeds the maximum or minimum flow rates of the boiler, or if the system flow rates are unknown.

The low-loss header is available as accessory part.

Please note location of expansion tank.

System separation is required of underfloor heating systems employing non-oxygen diffusion barrier tubing. All components on the secondary side of the heat exchanger must be made of corrosion-resistant materials.

The 3-way mixing valve, built-in to achieve the low temperature level of the under floor heating circuit, is controlled by an accessory kit for a heating circuit with mixing valve.



Refer to the boiler Installation Instructions for additional information.

## System Layout 4

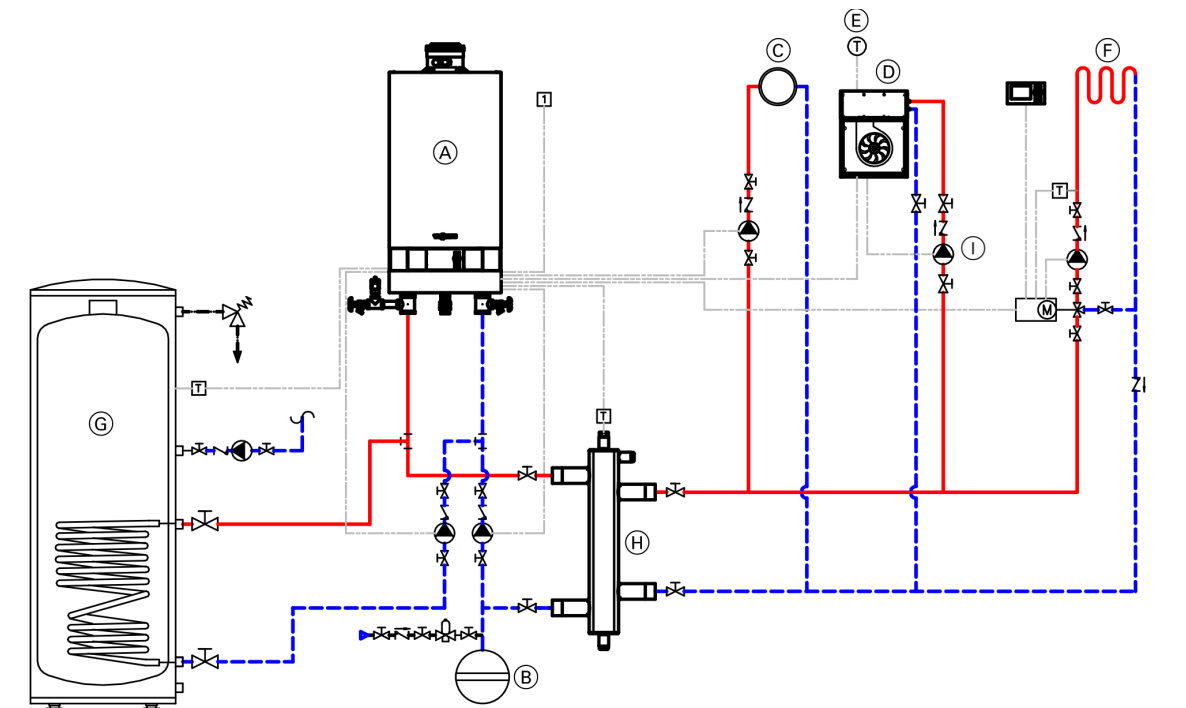

### Legend

- (A) Viessmann Vitodens 200 B2HA/B boilers
- (B) System fill with expansion tank
- (C) High temperature heating loop
- (D) Nu-Air HA air handler
- (E) Thermostat (field supplied)
- (F) Low temperature heating loop with mixing valve
- (G) Indirect fired DHW storage tank
- (H) Low loss header (or closely spaced tees)
- (I) Air handler pump

**Note:** System layout is for concept purposes only.

### IMPORTANT

The use of a low-loss header (or closely spaced tees with a maximum spacing of 4X pipe diameter) is strongly recommended if the maximum water flow rate in the application concerned exceeds the maximum or minimum flow rates of the boiler, or if the system flow rates are unknown.

The low-loss header is available as accessory part.

Please note location of expansion tank.

System separation is required of underfloor heating systems employing non-oxygen diffusion barrier tubing. All components on the secondary side of the heat exchanger must be made of corrosion-resistant materials.

The 3-way mixing valve, built-in to achieve the low temperature level of the under floor heating circuit, is controlled by an accessory kit for a heating circuit with mixing valve.



Refer to the boiler Installation Instructions for additional information.

## System Layout 5

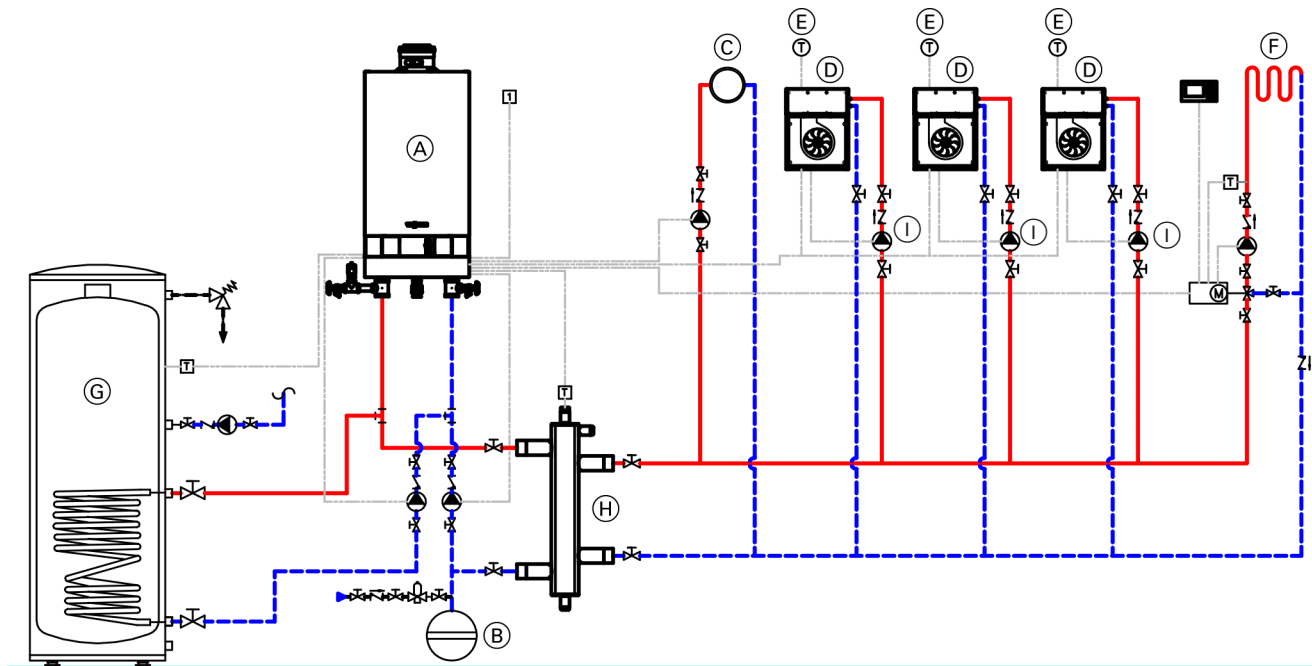

### Legend

- (A) Viessmann Vitocrossal 300 CU3A high mass boiler / Vitodens 200 B2HA/B boilers (shown)
- (B) System fill with expansion tank
- (C) High temperature heating loop
- (D) Nu-Air HA air handler
- (E) Thermostat (field supplied)
- (F) Low temperature heating loop with mixing valve
- (G) Indirect fired DHW storage tank
- (H) Low loss header (or closely spaced tees)
- (I) Air handler pump

**Note:** For installations with multiple air handler units, the call for heat from each air handler must be connected in parallel to the boiler demand.

**Note:** The low loss header is optional with the Viessmann Vitocrossal 300 CU3A boiler.

**Note:** System layout is for concept purposes only.

### IMPORTANT

The use of a low-loss header (or closely spaced tees with a maximum spacing of 4X pipe diameter) is strongly recommended if the maximum water flow rate in the application concerned exceeds the maximum or minimum flow rates of the boiler, or if the system flow rates are unknown.

The low-loss header is available as accessory part. Please note location of expansion tank.

System separation is required of underfloor heating systems employing non-oxygen diffusion barrier tubing. All components on the secondary side of the heat exchanger must be made of corrosion-resistant materials.

The 3-way mixing valve, built-in to achieve the low temperature level of the under floor heating circuit, is controlled by an accessory kit for a heating circuit with mixing valve.



Refer to the boiler Installation Instructions for additional information.

## System Layout 6

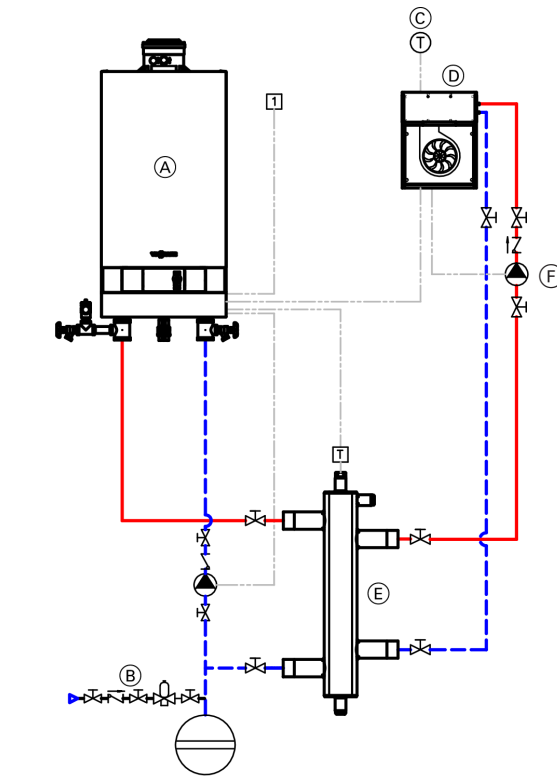

### Legend

- (A) Viessmann Vitodens 200 B2HA/B boilers
- (B) System fill with expansion tank
- (C) Thermostat (field supplied)
- (D) Nu-Air HA air handler
- (E) Low loss header (or closely spaced tees)
- (F) Air handler pump

**Note:** System layout is for concept purposes only.

### IMPORTANT

The use of a low-loss header (or closely spaced tees with a maximum spacing of 4X pipe diameter) is strongly recommended if the maximum water flow rate in the application concerned exceeds the maximum or minimum flow rates of the boiler, or if the system flow rates are unknown.

The low-loss header is available as accessory part.

Please note location of expansion tank.

Sizing of field-supplied pumps are critical for proper boiler operation in this system layout. An undersized pump may cause short-cycling and/or improper operation of the boiler.



Refer to the boiler Installation Instructions for additional information.

# System Layout 7

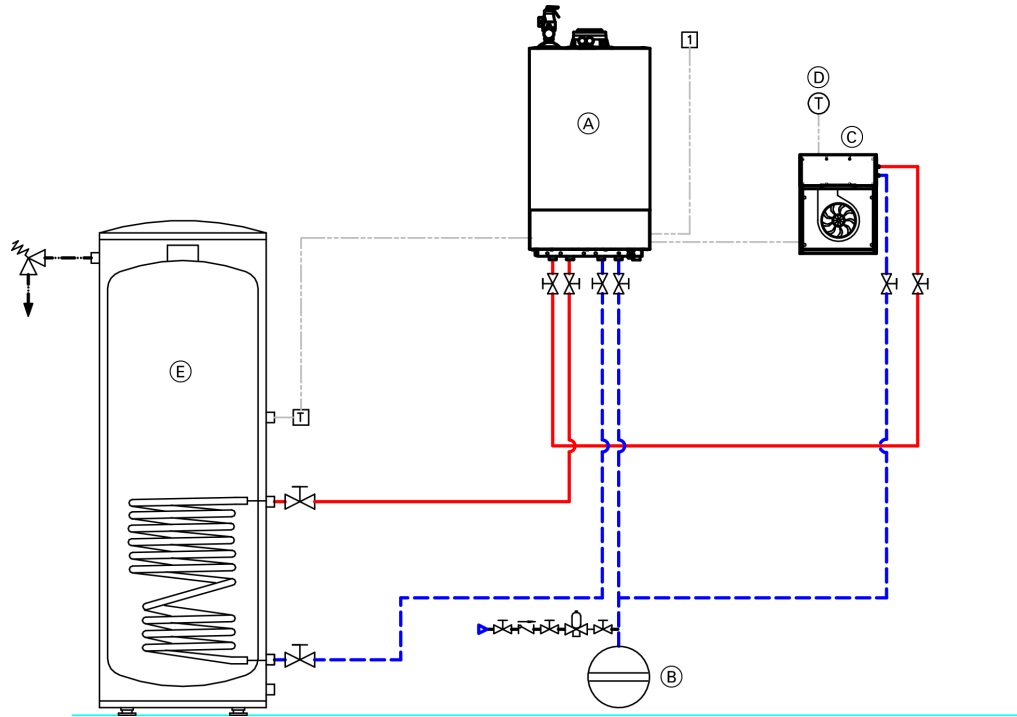

### Legend

- (A) Viessmann Vitodens 100 B1HE boiler
- (B) System fill with expansion tank
- (C) Nu-Air HA air handler
- (D) Thermostat (field supplied)
- (E) Indirect fired DHW storage tank

**Note:** System layout is for concept purposes only.

## IMPORTANT

**Please note location of expansion tank.**

**If the heating system does not include a DHW storage tank connected to the boiler the DHW demand contacts of the boiler may be connected to the Nu-Air HA heat demand, use the DHW temperature set point to set the desired supply temperature to the air handler.**

**Note:** The integrated boiler pump of the Viessmann Vitodens 100 B1HE boiler may eliminate the need for a dedicated air handler pump, refer to the installation instructions of the Vitodens boiler for available residual head.



Refer to the boiler Installation Instructions for additional information.

## System Layout 8

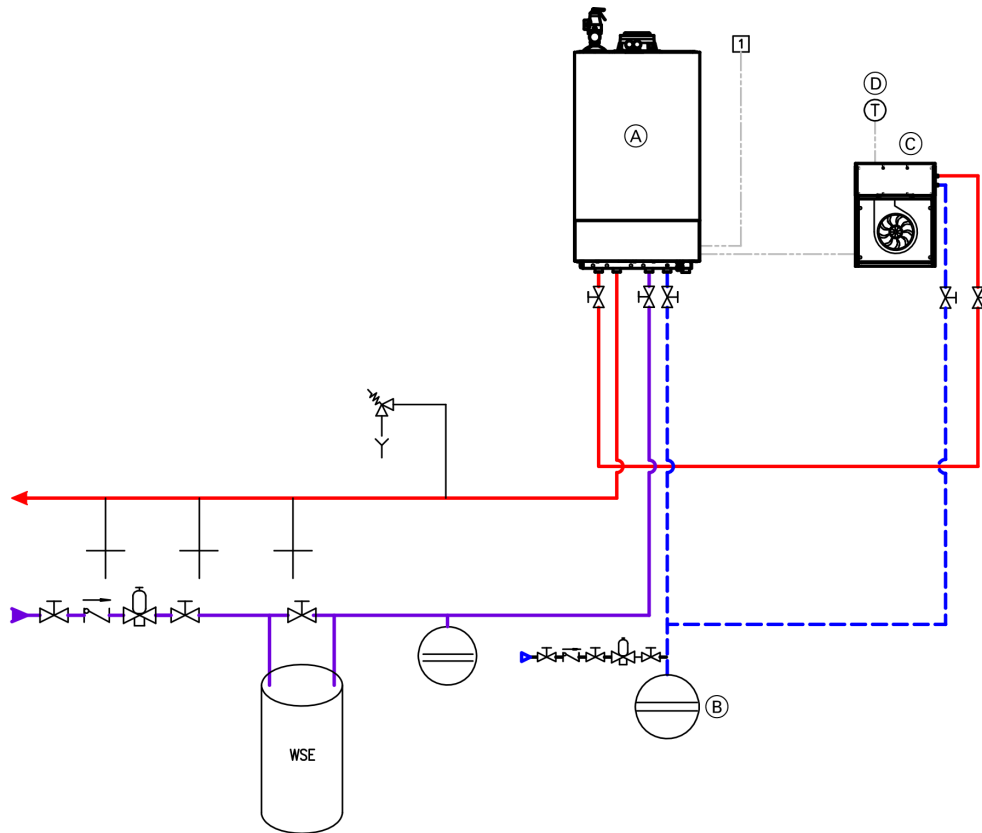

### Legend

- Ⓐ Viessmann Vitodens 100 B1KE boiler
- Ⓑ System fill with expansion tank
- Ⓒ Nu-Air HA air handler
- Ⓓ Thermostat (field supplied)

**Note:** System layout is for concept purposes only.

### IMPORTANT

**Please note location of expansion tank.**

**Note:** The integrated boiler pump of the Viessmann Vitodens 100 B1KE boiler may eliminate the need for a dedicated air handler pump, refer to the installation instructions of the Vitodens boiler for available residual head.



Refer to the boiler Installation Instructions for additional information.

# System Layout 9

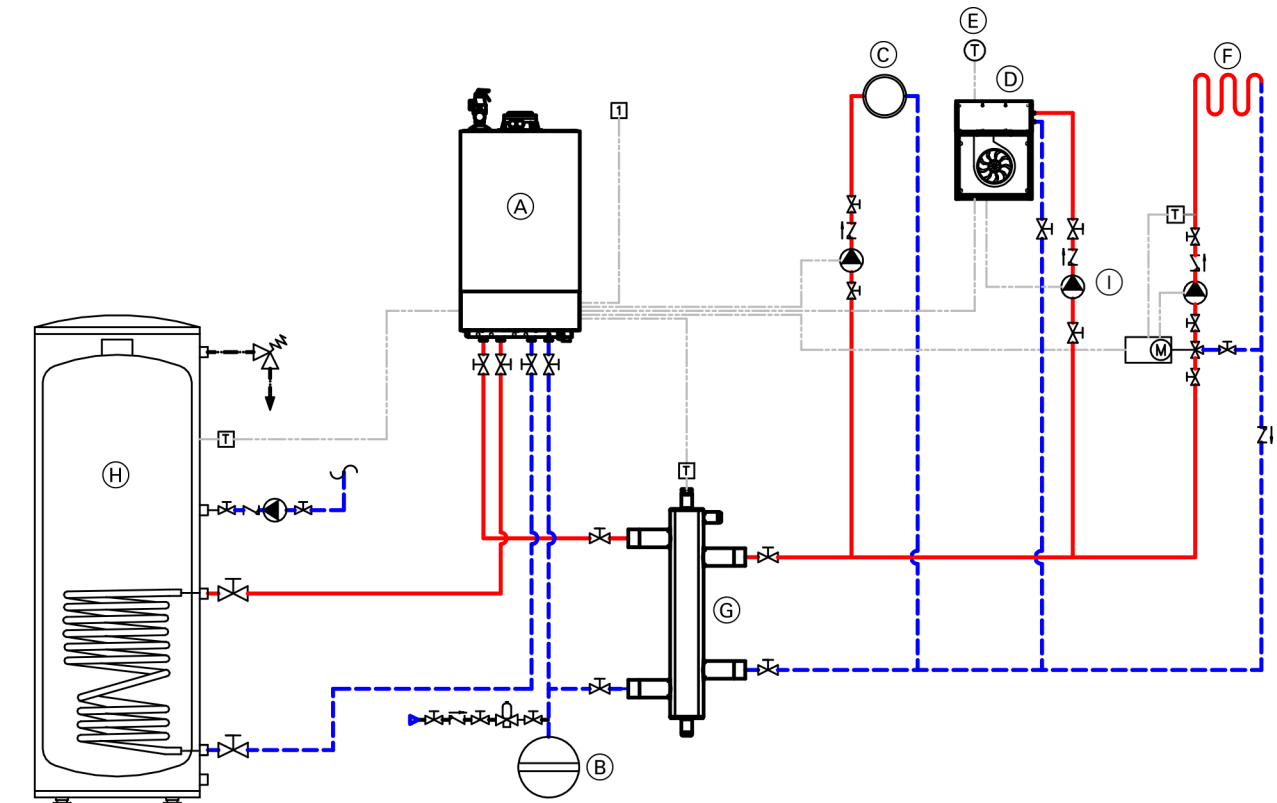

**Legend**

- (A) Viessmann Vitodens 200 B2HE series boiler
- (B) System fill with expansion tank
- (C) High temperature heating loop
- (D) Nu-Air HA air handler
- (E) Thermostat (field supplied)
- (F) Low temperature heating circuit with mixing valve
- (G) Low loss header (or closely spaced tees)
- (H) DHW tank
- (I) Air handler pump

**Note:** System layout is for concept purposes only.

## IMPORTANT

The use of a low-loss header (or closely spaced tees with a maximum spacing of 4X pipe diameter) is strongly recommended if the maximum water flow rate in the application concerned exceeds the maximum or minimum flow rates of the boiler, or if the system flow rates are unknown.

The low-loss header is available as accessory part. Please note location of expansion tank.

**Note:** The integrated boiler pump of the Viessmann Vitodens 200 B2HE boiler may eliminate the need for a dedicated air handler pump, refer to the installation instructions of the Vitodens boiler for available residual head.



Refer to the boiler Installation Instructions for additional information.

## System Layout 10

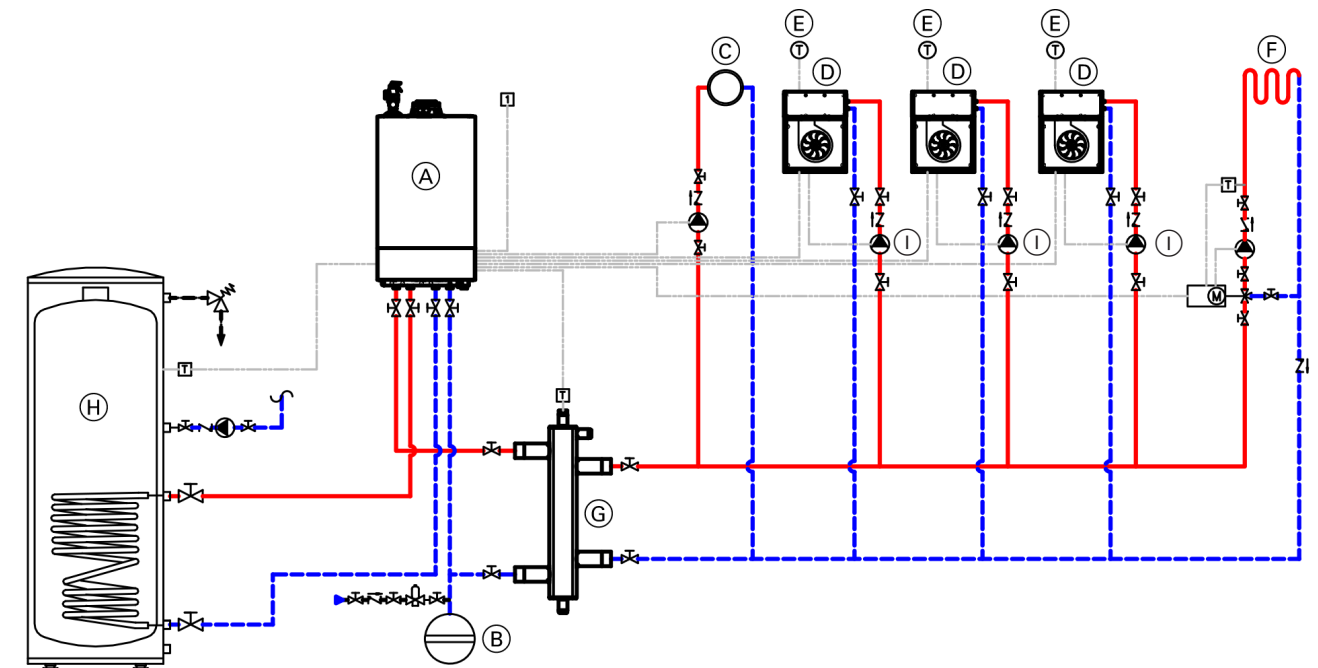

### Legend

- (A) Viessmann Vitodens 200 B2HE series boiler
- (B) System fill with expansion tank
- (C) High temperature heating loop
- (D) Nu-Air HA air handler
- (E) Thermostat (field supplied)
- (F) Low temperature heating circuit with mixing valve
- (G) Low loss header (or closely spaced tees)
- (H) DHW tank
- (I) Air handler pump

**Note:** System layout is for concept purposes only.

### IMPORTANT

The use of a low-loss header (or closely spaced tees with a maximum spacing of 4X pipe diameter) is strongly recommended if the maximum water flow rate in the application concerned exceeds the maximum or minimum flow rates of the boiler, or if the system flow rates are unknown.

The low-loss header is available as accessory part.

Please note location of expansion tank.



Refer to the boiler Installation Instructions for additional information.









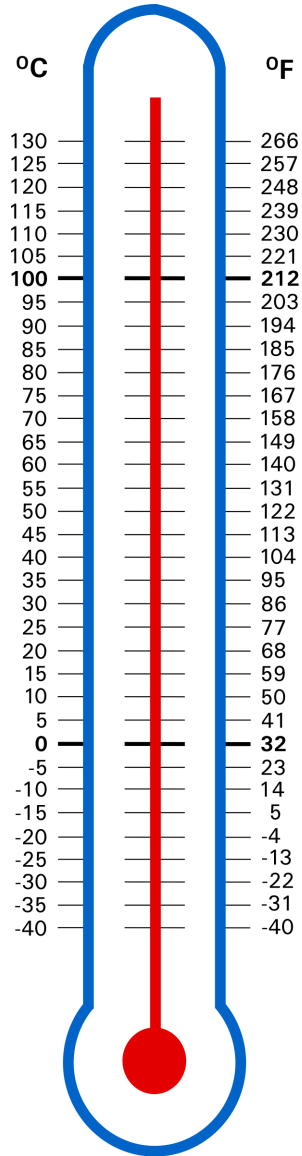

Printed on environmentally friendly  
(recycled and recyclable) paper.



Technical information subject to change without notice.