

# Operating Instructions

for use by heating contractor

**VIESSMANN**

Wood pellet boiler, with Ecotronic weather-compensated,  
digital boiler and heating circuit control unit  
Heating input: 44 MBH to 193 MBH  
13 kW to 57 kW



## VITOLIGNO 300-C



### **WARNING**

If the information in this manual is not followed exactly, a fire or explosion may result causing property damage, personal injury or loss of life.

Do not store or use gasoline or other flammable liquids in the vicinity of this or any other appliance.

#### WHAT TO DO IF YOU SMELL FLUE GAS

- Leave the premises immediately and call the fire department.

Installation and service must be performed by a qualified contractor.

### **WARNING**

Improper installation, adjustment, and/or operation could cause carbon monoxide poisoning resulting in injury or loss of life.

This product must be installed and serviced by a professional service technician who is experienced and qualified in hot water boiler installation.



*Product may not be exactly as shown*

### **IMPORTANT**

Read and save these instructions for future reference.

## Safety, Installation and Warranty Requirements

Please ensure that these instructions are read and understood before commencing installation. Failure to comply with the instructions listed below and details printed in this manual can cause product/property damage, severe personal injury, and/or loss of life. Ensure all requirements below are understood and fulfilled (including detailed information found in manual subsections).

### ■ Product documentation

Read all applicable documentation before commencing installation. Store documentation near boiler in a readily accessible location for reference in the future by service personnel.

► *For a listing of applicable literature, please see section entitled "Important Regulatory and Safety Requirements".*



### ■ Warranty

Information contained in this and related product documentation must be read and followed. Failure to do so renders the warranty null and void.



### ■ Licensed professional heating contractor

The installation, adjustment, service and maintenance of this equipment must be performed by a licensed professional heating contractor.

► *Please see section entitled "Important Regulatory and Installation Requirements".*



### ■ Contaminated air

Air contaminated by chemicals can cause by-products in the combustion process, which are poisonous to inhabitants and destructive to Viessmann equipment.

► *For a listing of chemicals which cannot be stored in or near the boiler room, please see subsection entitled "Mechanical Room".*



### ■ Advice to owner

Once the installation work is complete, the heating contractor must familiarize the system operator/ultimate owner with all equipment, as well as safety precautions/requirements, shutdown procedure, and the need for professional service annually before the heating season begins.

### ■ Carbon monoxide

Improper installation, adjustment, service and/or maintenance can cause flue products to flow into living space. Flue products contain poisonous carbon monoxide gas.

► *For information pertaining to the proper installation, adjustment, service and maintenance of this equipment to avoid formation of carbon monoxide, please see sections entitled "Mechanical Room" and "Venting Connection" in the Installation Instructions.*



### ■ Fresh air

This equipment requires fresh air for safe operation and must be installed ensuring provisions for adequate combustion and ventilation air exist.

► *For information pertaining to the fresh air requirements of this product, please see subsection entitled "Mechanical Room".*

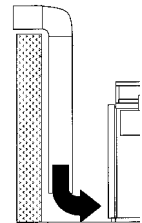

### ■ Equipment venting

Never operate boiler without an installed venting system. An improper venting system can cause carbon monoxide poisoning.

► *For information pertaining to venting and chimney requirements, please see section entitled "Venting Connection". All products of combustion must be safely vented to the outdoors.*



## ⚠ WARNING

**Installers must follow local regulations with respect to installation of carbon monoxide detectors. Follow the Viessmann maintenance schedule of the boiler contained in "Service Instructions".**

## Safety Instructions

### IMPORTANT

Please follow these safety instructions closely to prevent accidents and material losses.

#### Target group

These operating instructions are designed for heating system users. This appliance can also be operated by children of 8 years and older, as well as by individuals with reduced physical, sensory or mental faculties or those lacking in experience and knowledge, provided such individuals are being supervised or have been instructed in the safe use of this appliance as well as in any risks arising from it.

### IMPORTANT

Supervise children in the proximity of the appliance.

- Never permit children to play with the appliance.
- Cleaning and maintenance must not be carried out by unsupervised children.

#### Appliance connection

- The appliance may only be connected and commissioned by authorized contractors.
- Only operate the appliance with suitable fuels.
- Observe the specified electrical connection requirements.
- Modifications to the existing installation may only be carried out by authorized contractors.

### WARNING

Incorrectly executed work on the heating system can lead to life threatening accidents. Work on electrical equipment must only be carried out by a qualified electrician.

#### Work on the appliance

- All settings and work on the appliance must be carried out as specified in these operating instructions. Further work on the appliance may only be carried out by authorized contractors.
- Never change or remove attachments or fitted accessories.
- Never open or retighten pipe connections.

### WARNING

Hot surfaces can cause burns. Never touch the hot surfaces inside the appliance or those of uninsulated pipes, fittings or flue pipes.

#### If you smell flue gas

### WARNING

Flue gas can lead to life threatening poisoning.

- Shut down the heating system.
- Ventilate the installation site.
- Close all doors in the living space.

#### In case of fire

### WARNING

Fire presents a risk of burns and explosion.

- Shut down the heating system.
- Use a tested fire extinguisher, class ABC.

## Safety Instructions *(continued)*

### What to do if the heating system develops a fault

#### **WARNING**

Fault messages indicate faults in the heating system. If faults are not rectified, they can have life threatening consequences. Do not acknowledge fault messages several times in quick succession. Inform your heating contractor so the cause can be analyzed and the fault rectified.

### Conditions for siting

#### **WARNING**

Sealed vents result in a lack of combustion air. This leads to incomplete combustion and the formation of life threatening carbon monoxide. Never cover or close existing vents. Do not make any subsequent modifications to the building characteristics that could affect safe operation (e.g. cable/pipework routing, cladding or partitions).

#### **WARNING**

Easily flammable liquids and materials (e.g. naphtha, solvents, cleaning agents, paints or paper) can cause deflagration and fire. Never store or use such materials in the installation room or in direct proximity to the heating system.

#### **IMPORTANT**

Incorrect ambient conditions can lead to heating system damage and can put safe operation at risk.

- Ensure ambient temperatures are above 32°F (0°C) and below 95°F (35°C).
- Prevent air contamination by halogenated hydrocarbons (e.g. as contained in paints, solvents or cleaning fluids) and excessive dust (e.g. through grinding/polishing work).
- Avoid continuously high humidity levels (e.g. through continuous drying of washing).

### Extractors

The operation of appliances that extract air to the outside (range hoods, extractors, air conditioning units, etc.) can create vacuum pressure. If the boiler is operated at the same time, this can lead to reverse flow of the flue gas.

#### **WARNING**

The simultaneous operation of the boiler and appliances that extract air to the outside can result in life threatening poisoning due to reverse flow of the flue gas. Take suitable steps to ensure an adequate supply of combustion air. If necessary, contact your heating contractor.

### Auxiliary components, spare and wearing parts

#### **IMPORTANT**

Components not tested with the heating system may damage the system or affect its function. Have all installation or replacement work carried out exclusively by qualified contractors.

	Page
<b>Safety</b>	<b>Safety, Installation and Warranty Requirements.....2</b>
	<b>Safety Instructions .....3</b>
<b>Introduction</b>	<b>About These Instructions .....7</b>
	<b>Product Information .....7</b>
	<b>Ordering Fuel .....8</b>
	<b>Commissioning .....9</b>
	<b>Regular Service Inspection.....9</b>
	<b>Your System is Preset at the Factory .....10</b>
	<b>Energy Saving Tips.....10</b>
<b>Boiler</b>	<b>Boiler Control and Components .....11</b>
	<b>Control Unit Controls and Display Elements .....12</b>
	<b>Heat-up Preparations .....12</b>
	<b>Action in the Event of Boiler Overheating .....13</b>
<b>Control</b>	<b>Navigation in the Control Unit Menu .....14</b>
	<b>Menu Structure of the Control Unit.....15</b>
<b>Central Heating</b>	<b>Required Settings .....17</b>
	<b>Select a Heating Circuit.....17</b>
	<b>Setting the Room Temperature.....18</b>
	<b>Setting the Operating Program .....19</b>
	<b>Setting the Time Program.....19</b>
	<b>Changing the Heating Curve .....21</b>
	<b>Stopping Central Heating.....23</b>
<b>Comfort and Energy Saving Function</b>	<b>Selecting Party Mode.....24</b>
	<b>Selecting Economy Mode .....25</b>
	<b>Selecting the Holiday Program .....26</b>
<b>DHW Heating</b>	<b>Required Settings .....28</b>
	<b>Setting the DHW Temperature .....28</b>
	<b>Setting the Operating Program .....28</b>
	<b>Setting the Time Program.....29</b>
	<b>Stopping DHW Heating .....30</b>
<b>Heating Water Buffer Tank</b>	<b>Setting the Operating Program .....31</b>
	<b>Setting the Time Program.....32</b>
	<b>Setting the Heating Curve .....33</b>
<b>Fuel Supply</b>	<b>Blocking Times for Automatic Fuel Supply .....34</b>

**Further Adjustments**

Settings the Display Contrast.....	35
Setting the Display Brightness.....	35
Naming the Heating Circuits .....	36
Setting the Time and Date.....	37
Setting the Language.....	37
Settings the Temperature Unit (°C to °F).....	37
Changing the Boiler Water Temperature .....	38
Setting the Minimum System Temperature .....	38
Restoring the Factory Settings .....	38

**Scanning**

Scanning Fault Messages .....	39
Scanning Information.....	40
Shutting Down the Heating System for an Extended Period.....	41
Shutdown .....	41

**Troubleshooting**

Rooms are Too Cold .....	42
Rooms are Too Hot .....	42
There is No Hot Water .....	43
The DHW is Too Hot .....	43
“Fault” is Shown on the Display.....	43
“Solar Risk of Overheating” Appears on the Display.....	43

**Maintenance**

Inspection/Cleaning/Maintenance.....	44
Replacing Fuses .....	44
Overview of Maintenance and Cleaning Work in the boiler..	45
Emptying the Ash Box .....	46
Terminology .....	47
Efficient and Clean Operation.....	51
Dismantling .....	51
General Energy Saving Tips .....	51

## About These Instructions

 Take note of all symbols and notations intended to draw attention to potential hazards or important product information. These include "WARNING", "CAUTION", and "IMPORTANT". See below.



### WARNING

Warnings draw your attention to the presence of potential hazards or important product information.

- ▶ Indicates an imminently hazardous situation which, if not avoided, could result in death, serious injury or substantial product/property damage.



### CAUTION

Cautions draw your attention to the presence of potential hazards or important product information.

- ▶ Indicates an imminently hazardous situation which, if not avoided, may result in minor injury or product / property damage.

### IMPORTANT

- ▶ Helpful hints for installation, operation or maintenance which pertain to the product.



- ▶ This symbol indicates to note additional information



- ▶ This symbol indicates that other instructions must be referenced.

## Product Information

The Viessmann Vitoligno 300-C boiler series is CSA certified for Canada, is constructed in compliance with CSA B51 Standard and carries Canadian Registration Numbers. The boiler is suitable for a maximum operating pressure of 45 psig and a maximum boiler water temperature of 230°F (110°C).

The Vitoligno 300-C boiler must only be installed in closed loop hot water heating systems using a pre-charged membrane expansion tank.

Intended use presupposes that a fixed installation in conjunction with permissible, system-specific components has been carried out.

Commercial or industrial usage for a purpose other than heating the building or DHW shall be deemed inappropriate.

Any usage beyond this must be approved by the manufacturer in each individual case.

Incorrect usage or operation of the appliance (e.g. the appliance being operated for longer periods when open) is prohibited and will result in an exclusion of liability. Incorrect usage also occurs if the components in the heating system are modified from their intended use (e.g. if the flue gas and ventilation air paths are, sealed) or if other fuels than those intended for this appliance are used.

## Ordering Fuel

### IMPORTANT

If different fuels are used, Viessmann will not assume any liability for the functioning or service life of the boiler plant. Refer to the "Warranty" section in the General Terms and Conditions of Delivery.

- Burn wood pellets only
- Do not use chemicals or fluids to start fire.
- Do not burn any type of waste or garbage.
- Do not burn gasoline, naphtha, engine oil, or other inappropriate materials.
- Do not use chemicals or fluids to start fire.

#### What are wood pellets?

Wood pellets are made from 100 percent natural wood remnants. This raw material is waste matter created by the wood industry in large volumes through planing or sawing. Wood remnants are compressed under high pressure and formed into pellets, i.e. pressed into a cylindrical shape. The raw material is stored and transported under completely dry conditions. System users should also ensure completely dry storage conditions. This is the only way to guarantee optimum and effective combustion.

#### Delivery methods

Pellets are sold in sacks, in bulk on pallets and loose. In their loose form, pellets are transported by silo tanker and pumped into the storage room via a hose system. Careful handling of pellets ensures a low proportion of dust, perfect fuel charging and a constant boiler heating output.

**Note:** The pellet vacuum system hopper inside the boiler has a capacity of approx. 3.5 cu. ft (100 L). This corresponds to approx. 143 lbs. (65 Kg) of pellets.

#### Pellet requirements

It is recommended that the pellets used comply with the requirements of the Pellet Fuel Institute (PFI - Standard or PFI - Premium) and/or CANPlus grade A1 and/or CAN/CSA - ISO 17225 Part 2 Standard.

Requirement		PFI - Standard	CANPlus-A1	Specification as per CAN/CSA ISO 17225-2 Grade A1
Diameter		.230 - .285 in. (5.84 - 7.25 mm)	0.236 ± 0.039 in. (6 ± 1 mm)	D06
Length		A maximum of 1% may be longer than 1.5 in. (38 mm)	A maximum of 1% may be longer than 1.7 in. (40 mm), but no longer than 1.77 in. (45 mm)	0.125 to 1.575 in. (3.15 to 40 mm)
Bulk density in delivered condition	lb/cuft (kg/m³)	38-48 (608-769)	37-47 (600 to 750)	(BD600)
Net calorific value in the delivered condition	MJ/kg kWh/kg	-- --	≥ 16.5 ≥ 4.6	Q16.5 Q4.6
Water content in delivered condition	m-%	≤ 10	≥ 10	M10
Fines content in the delivered condition	m-%	≤ 1	≤ 1	F1.0
Mechanical strength in the delivered condition	m-%	≥ 95	≤ 97.5	DU 97.5
Ash content, free from water	%		≤ 0.7	A0.7
Ash softening temperature	°F	--	≤ 2200	--
This value is only binding for pellets certified to CANPlus.	(°C)	--	(≤ 1200)	--
Chlorine content, free from water	m-%	≤ 300 ppm	≤ 0.02	C10.2
Sulphur content, free from water	m-%	--	≤ 0.04	S0.04
Nitrogen content, free from water	m-%	--	≤ 0.3	N0.03

m-% = percentage by mass

Consequence of overstepping particle size:

- Increased maintenance because of a substantially higher risk of malfunction
- Shortened service life of the conveyor augers and drives



## Commissioning

Commissioning and adjusting the control unit to local conditions and the structural characteristics of the building must be carried out by your heating contractor.

As the user of new combustion equipment, you may be obliged to notify your local heating contractor of the installation [check local regulations]. Your local heating contractor [where applicable] will also provide you with information on additional activities concerning your combustion equipment (such as regular testing, cleaning, etc.).



Refer to the Installation and Service Instructions.

## Regular Service Inspection

- Your heating contractor must prepare the boiler for this test.
- Notify your heating contractor approx. 2 weeks prior to the next service inspection being due.
- Ensure that suitable fuel in line with these operating instructions is available.



Refer to the Installation and Service Instructions.

## Your System is Preset at the Factory

Your boiler's control unit is set at the factory.

- The heating circuits are set to the "Heating" operating program.
- The domestic hot water heating is set to the "DHW" operating program.

Your heating system is therefore ready for operation:

### Central heating

- From 6:00 am to 10:00 pm (06:00 to 22:00 h) your rooms are heated to 72°F (22°C) "Set room temp" (standard heating mode).
- From 10:00 pm to 6:00 am (22:00 to 06:00 h), your rooms will be heated to "Set red room temp" (room temperature for reduced heating mode, night setback).
- Your heating contractor can make further settings for you during commissioning. You can change any settings at any time to suit your individual requirements (see from page 18).

### DHW heating

- DHW is heated to 140°F (60°C) "Set DHW temperature" every day from 12:00 am to 12:00 am (00:00 to 24:00 h).
- Your heating contractor can make further settings for you during commissioning. You can change any settings at any time to suit your individual requirements (see from page 28).

### Frost protection

- Your boiler, DHW tank and heating water buffer tank are protected against frost. Wintertime/summertime changeover
- This changeover is automatic.

### Time and date

- The day and time were set by your heating contractor during commissioning.

### Power failure

- All data is retained if there is a power failure.

## Energy Saving Tips

### Energy saving tips

Use the adjustment options offered by your boiler control unit:

- For central heating, select the operating program that meets your current requirements:
  - For short periods of absence (a few hours, such as shopping trips), select "Economy mode" (see page 25). The room temperature is reduced for as long as economy mode is active.
  - If you are going away, set the "Holiday program" (see page 26). The operating program for central heating is automatically set to "Standby mode" while the holiday program is active.
  - If, for an extended period, you neither want to heat the interior nor do you require DHW, select the "Standby mode" operating program for the relevant heating circuits and for DHW.
  - See page 23 for the relevant heating circuits
  - See page 28 for DHW heating
- Never set the DHW tank temperature excessively high (see page 28).

Contact your heating contractor for additional energy saving functions offered by your boiler control unit. For general recommendations on energy savings, see page 51.

## Boiler Controls and Components

Supply via vacuum system

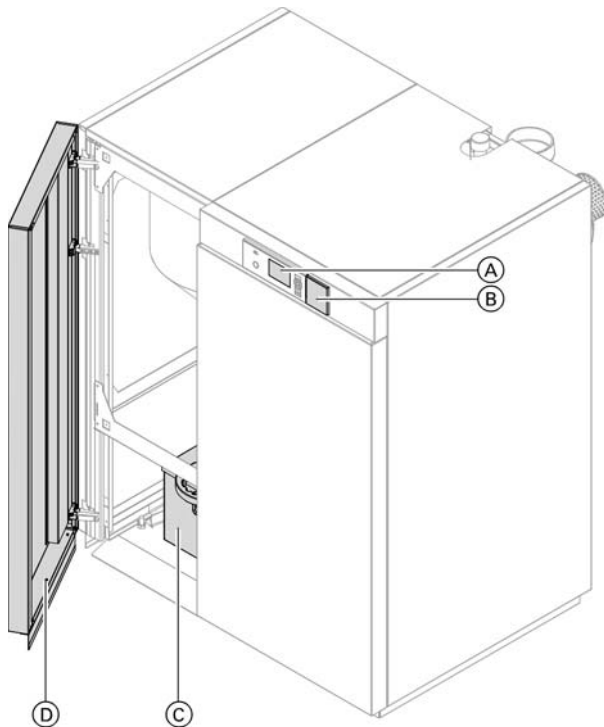

Supply via flexible screw conveyor

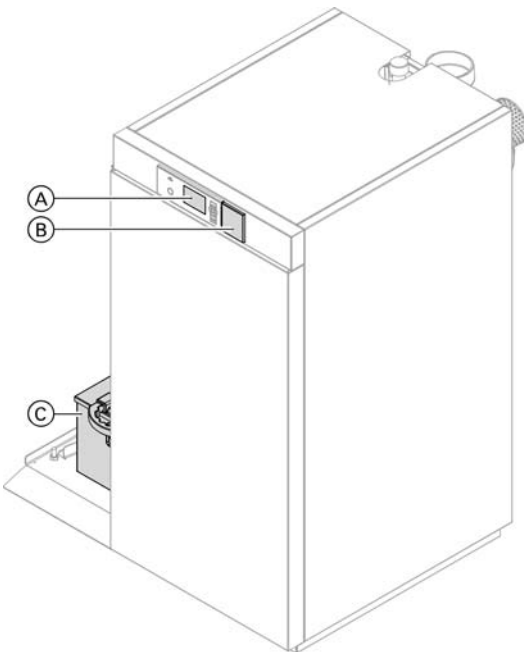

### Legend

- Ⓐ Programming unit of the control unit
- Ⓑ Appliance ON/OFF switch and reset button for high limit safety cut-out behind the cover
- Ⓒ Ash box
- Ⓓ Access door (system with vacuum supply only)

### WARNING

The appliance ON/OFF switch (behind cover Ⓑ) is used to isolate the control unit from the power supply. It does not turn off the mains power supply. There are live components inside the control unit enclosure.

**Note:** You will find an overview of the cleaning and maintenance tasks from page 45.

## Control Unit Controls and Display Elements

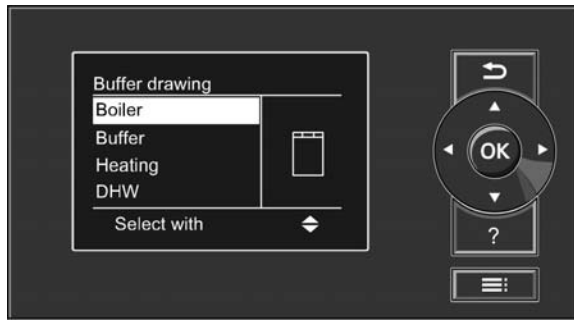

### The programming unit

You can adjust all control unit settings centrally at the programming unit.

- Takes you to the previous step in the menu or cancels a setting that has been started.
- Cursor keys  
Scrolls through the menu or adjusts values.
- To confirm your selection or save the setting you've made.
- Calls up the help text relevant to the selected menu point.
- Calls up the extended menu.

For operating the control unit, see from page 14.

## Heat-up Preparations

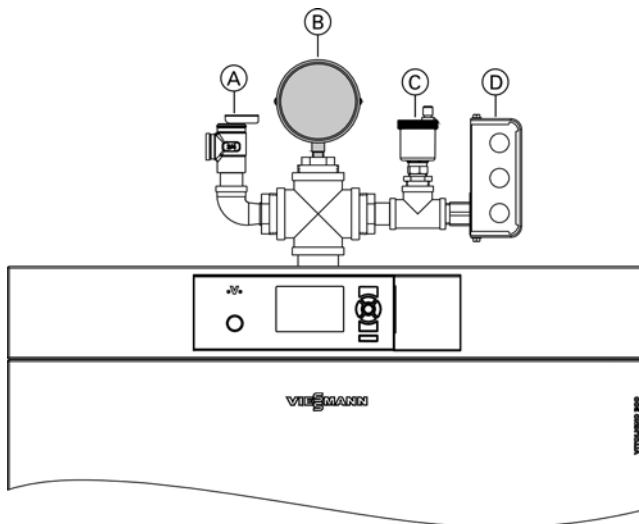

### Legend

- (A) Pressure relief valve (PRV)
- (B) Temperature and pressure gauge
- (C) Air vent
- (D) Low water cutoff

Ask your heating contractor about the following:

- Boiler type and relevant control unit type
- Required system pressure
- Location of the pressure gauge, shut-off valve, gas shut-off valve, ventilation apertures

1. Check the pressure of the heating system at pressure gauge (B):  
The system pressure is too low if the indicator points below the minimum operating pressure. In this case, top up with water or notify your heating contractor. Minimum system pressure: 14.5 psi (1.0 bar).
2. Check that the vents in the installation room are unrestricted.  
**Note:** With room air dependant operation, the combustion air is drawn from the installation room.
3. Verify that the heating system or the heating water buffer tank is drawing off heat. Open the thermostatic valves on the radiators if necessary.
4. Ensure that all heating supply and heating return shut-off gate valves are open.
5. Check that all covers on the boiler are closed.
6. Ensure that power is supplied to the boiler.

## Action in the Event of Boiler Overheating

The high limit safety cut-out protects your boiler from overheating.

**Note:** Never make adjustments at the high limit safety cutout, which would result in an exclusion of liability. Replace faulty components only with genuine spare parts from Viessmann.

**Note:** Notify your heating contractor if the boiler overheats again after a short time or overheats regularly.

### Boiler water temperature has reached 230°F (110°C) High limit safety cut-out

The reset button of the high limit safety cut-out is located behind cover (A) of the programming unit.

**Note:** Any high limit safety cut-out response requires a manual reset.

#### Triggering the function:

The high limit safety cut-out will respond if the boiler water temperature exceeds 230°F (110°C).

#### Resetting the fixed high limit

**Note:** The high limit safety cut-out can only be reset once the boiler water temperature has reached approx. 140°F (60°C).

1. Slide cover (A) on the programming unit to the right.
2. Press the green button on the high limit safety cutout. A quiet "click" will be audible. The high limit safety cut-out has been reset.
3. Close the programming unit cover.
4. Acknowledge the excess temperature on the programming unit of the control unit with (OK).

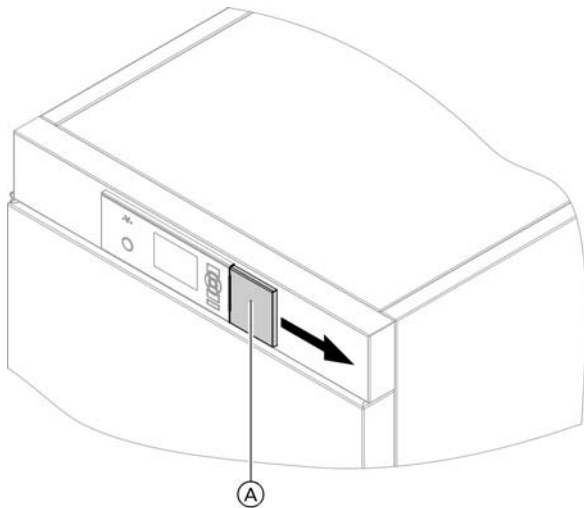

# Navigation in the Control Unit Menu

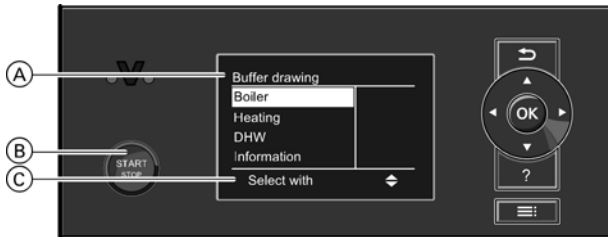

**Legend**

- (A) Display of operating phase
- (B) Start-stop pushbutton
- (C) Dialogue line

The selected menu point is highlighted in white.  
Dialogue line (C) gives the necessary instructions.

Example: Procedure for settings with different dialogue lines

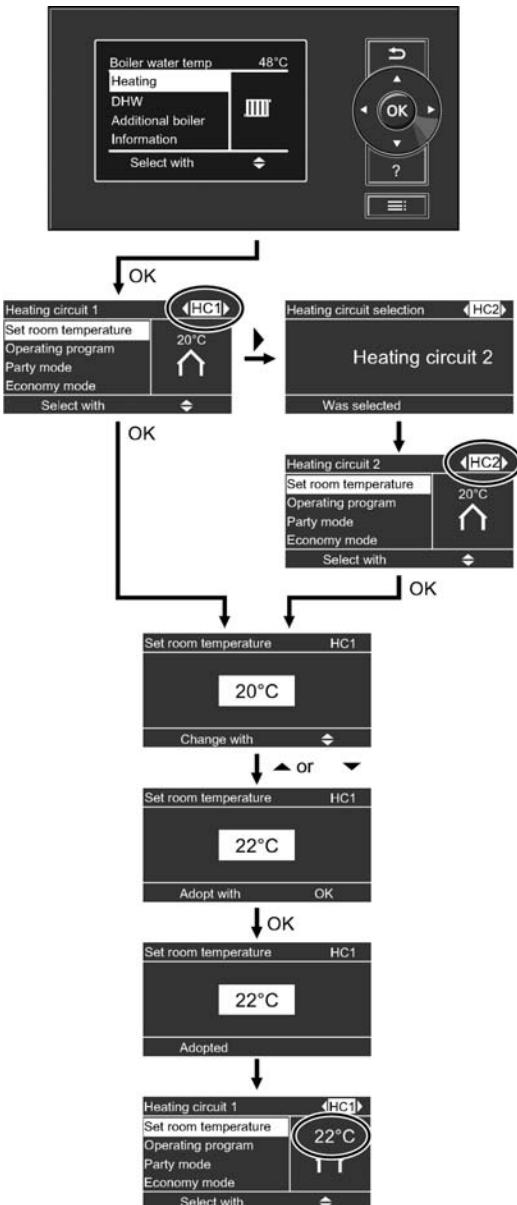

**Start-Stop pushbutton function (B)**

**Start-stop pushbutton:**

Does not illuminate	The boiler is off; no frost protection.
Illuminates	The boiler is in standby mode and will start automatically on demand or the boiler is operating.
Flashes	The boiler completely burns the available fuel or An external demand via coding address 44 was activated
■ Flashing slowly	<b>Note:</b> The start-stop pushbutton is disabled if an external programming unit is connected. The boiler can only be switched on and off via the external unit. Contact at plug 270 closed There is an external demand.
■ Flashing rapidly	Contact at plug 270 open There is no current demand.

## Menu Structure of the Control Unit

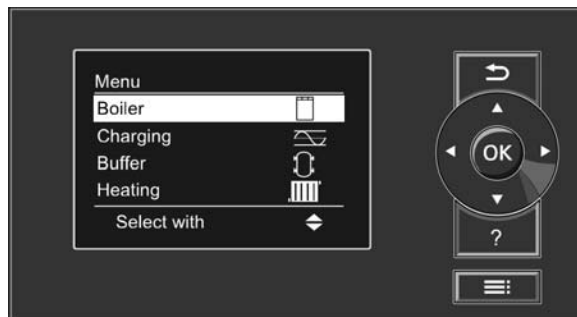
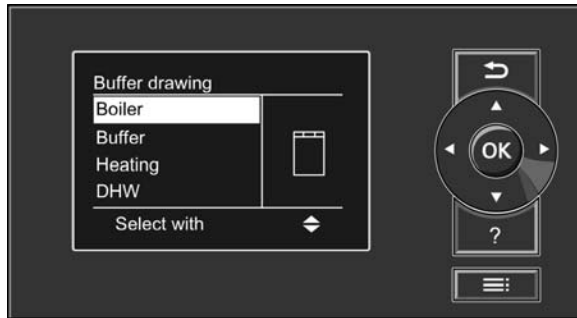

There are 2 control levels available: the “Standard menu” and the “Extended menu”.

### Standard menu

You can call up the settings you require most frequently from the standard menu:

- Select the set room temperature.
- Set the operating program.
- Set the “Party mode” comfort function.
- Set the energy saving function “Economy mode”.
- Scan the operating status.
- Calling up temperatures, e.g. outdoor temperatures
- Scan information.
- Scan notes, warning and fault messages.

Call up the standard menu as follows:

- If the screensaver is active: Press any key.
- From anywhere in the menu: Press ↶ repeatedly until the standard menu appears.

### Extended menu

In the extended menu, you can call up and adjust the settings of the control unit’s range of less frequently required functions, holiday program and time programs for example.

Call up the extended menu as follows:

- If the screensaver is active: Press any key followed by ≡.
- From anywhere in the menu: Press ≡.

**Menu Structure of the Control Unit** *(continued)*

Screensaver during operating phase "Boiler load operation"

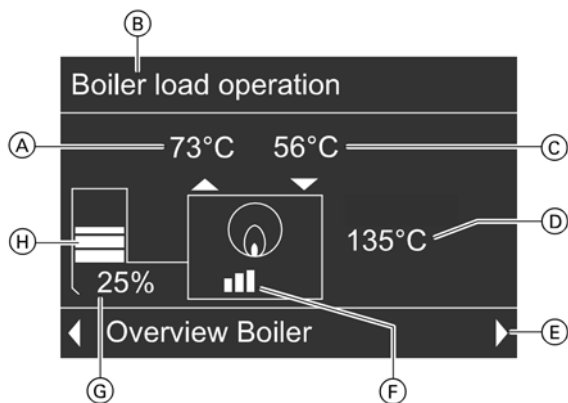

**Legend**

- Ⓐ Boiler supply temperature 163°F (73°C)
- Ⓑ Operating phase
- Ⓒ Boiler return temperature 133°F (56°C)
- Ⓓ Flue gas temperature 275°F (135°C)
- Ⓔ Dialogue line
- Ⓕ Boiler heating output
- Ⓖ Feed delivery rate (pellets)
- Ⓗ Pellet hopper fill level (where installed)

**Screensaver**

- The screensaver will be enabled if no adjustments are made on the programming unit for a few minutes.
- Depending on the operating phase, the screensaver will inform you about the current values of the boiler or heating water buffer tank.

Press any key. This takes you to the standard menu (see page 15).

**"Help" menu**

You can view an abridged guide giving an explanation of the controls and information about heating circuit selection.

Call up the short guide as follows:

- From anywhere in the menu:  
Call up the "Help" menu point by pressing "?".

Screensaver during operating phase "Buffer drawing"

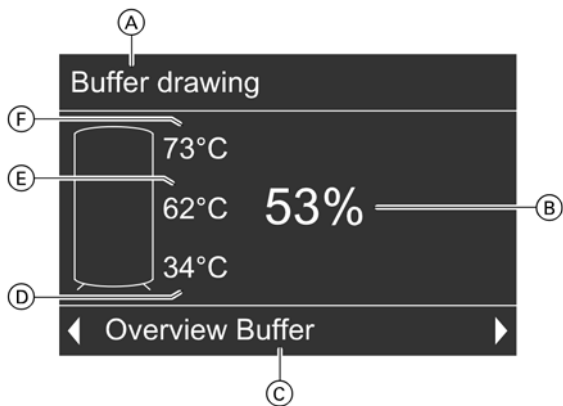

**Legend**

- Ⓐ Operating phase
- Ⓑ Heating water buffer tank heat-up condition in %
- Ⓒ Dialogue line
- Ⓓ Heating water buffer tank temperature - bottom, 93°F (34°C)
- Ⓔ Heating water buffer tank temperature - centre, 144°F (62°C)
- Ⓕ Heating water buffer tank temperature - top, 163°F (73°C)



## Required Settings

If you require central heating, check the following points:

- Have you selected the heating circuit?  
For settings, see chapter “Selecting a heating circuit” on page 17.
- Have you set the required room temperature?  
For settings, see page 18.
- Have you set the correct operating program?  
For settings, see page 23.
- Have you set the required time program?  
For settings, see page 19.

## Selecting a Heating Circuit

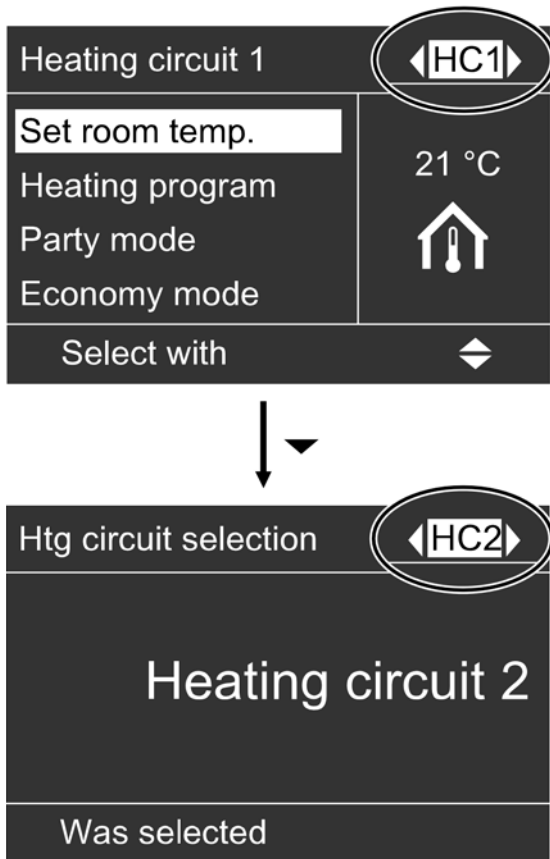

The heating of your rooms can be split over several heating circuits if necessary.

- In the case of heating systems with several heating circuits, for all central heating settings, first select the heating circuit for which you want to make a change.
- This selection is not available in heating systems with only one heating circuit.

The heating circuits are marked at the factory as “Heating circuit 1” (HC1) and “Heating circuit 2” (HC2).

Example:

- “Heating circuit 1” is the heating circuit for the rooms occupied by you.
- “Heating circuit 2” is the heating circuit for the rooms of a separate apartment.

If you or your heating contractor have renamed the heating circuits (as “Apartment” for example), that title is then displayed instead of “Heating circuit 1” (see page 36).

## Setting the Room Temperature

You can set the standard room temperature (for day) and the reduced room temperature (for night) for the relevant heating circuit.

### Setting the standard room temperature for standard heating mode

Press the following keys in the standard menu:

1. ▲/▼ to select "Heating"
2. Ⓞ to confirm.
3. ⬅/➡ to select "Heating circuit 1" (HC1), "Heating circuit 2" (HC2), "Heating circuit 3" (HC3) or "Heating circuit 4" (HC4).
4. ▲/▼ for "Set room temp".
5. Ⓞ to confirm.
6. ▲/▼ for the required temperature.
7. Ⓞ to confirm.  
"Adopted" appears briefly in the dialogue line of the display.
8. ↶ until the default display is shown.

### Set the room temperature for reduced heating mode (night setback)

Press the following keys:

1. ≡ for "Extended menu".
2. ▲/▼ to select "Heating".
3. Ⓞ to confirm.
4. ⬅/➡ to select "Heating circuit 1" (HC1), "Heating circuit 2" (HC2), "Heating circuit 3" (HC3) or "Heating circuit 4" (HC4).
5. ▲/▼ for "Set red room temp".
6. Ⓞ to confirm.
7. ▲/▼ for the required temperature.
8. Ⓞ to confirm.  
"Adopted" appears briefly in the dialogue line of the display.
9. ↶ until the default display is shown.

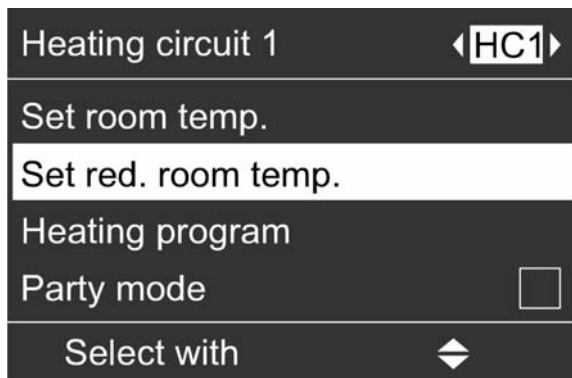

## Setting the Operating Program

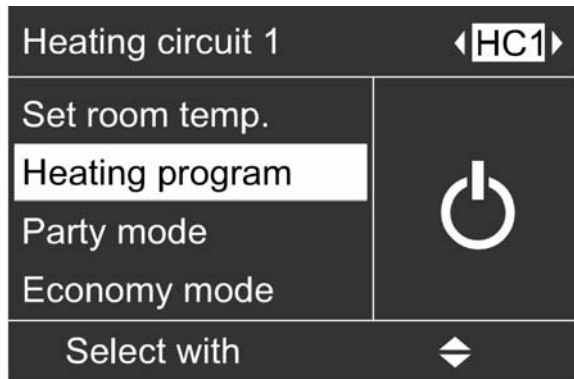

Check if "Heating" is set for the relevant heating circuit.  
Press the following keys in the standard menu:

1. ▲/▼ for "Heating"
2. Ⓚ to confirm.
3. ⏪/⏩ to select "Heating circuit 1" (HC1), "Heating circuit 2" (HC2), "Heating circuit 3" (HC3) or "Heating circuit 4" (HC4).
4. ▲/▼ for "Operating program".
5. Ⓚ to confirm.  
The check mark must be next to "Heating".  
If not, proceed as follows:
6. ▲/▼ for "Heating".
7. Ⓚ to confirm.
8. ↶ until the default display is shown.

The rooms of the selected heating circuit are heated in accordance with the room temperature and time program settings.

## Setting a Time Program

The times at which the heating circuit delivers central heating with standard or reduced room temperature depends on the setting of the switching times for the relevant day (4 possible time phases).

- If one or more time phases are set, central heating with standard room temperature is active during those times.
- If no time phases are set, central heating is carried out to the reduced room temperature for the whole day.

Press the following keys:

1. ≡ for "Extended menu".
2. ▲/▼ to select "Heating".
3. Ⓚ to confirm.
4. ⏪/⏩ to select "Heating circuit 1" (HC1), "Heating circuit 2" (HC2), "Heating circuit 3" (HC3) or "Heating circuit 4" (HC4).
5. ▲/▼ for "Heating time program".
6. Ⓚ to confirm.
7. ▲/▼ for adjusting the required time. (see sections below)
8. ↶ until the default display is shown.

**Setting a Time Program** *(continued)*

- For central heating, up to 4 changes between standard and reduced room temperature can be programmed per day (4 time phases).
- At the factory, time phase 1 is set for every day from 6:00 am to 10:00 pm (06:00 to 22:00 h). During that time, all rooms are heated to the standard room temperature.
- You can set switching times individually for the following days or parts of the week:
  - Same for all days of the week: Monday to Sunday
  - For individual parts of the week: Monday to Friday and Saturday to Sunday
  - For each day individually: Monday, Tuesday, etc.

When setting switching times, note that your heating system requires some time to heat the interior to the required temperature.

- For the steps to set switching times.
- For the steps to delete a time phase, see page 21.

**Note:** For the period between the specified switching times, the relevant heating circuit is regulated to the standard room temperature.

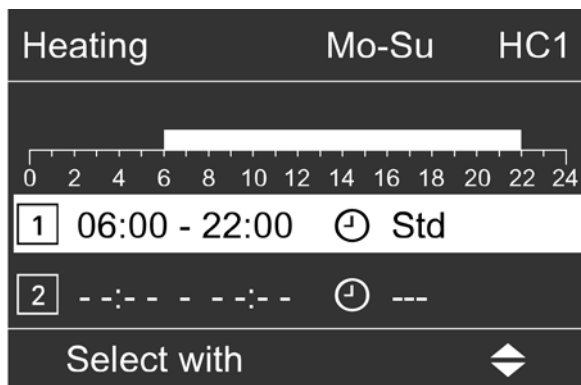
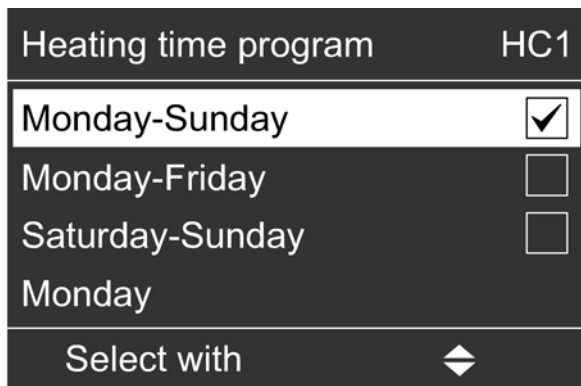

**Setting switching times**

Press the following keys:

1. : for "Extended menu".
2. to select "Heating".
3. to select "Heating circuit 1" (HC1), "Heating circuit 2" (HC2), "Heating circuit 3" (HC3) or "Heating circuit 4" (HC4).
4. for "Heating time program".
5. to confirm.
  - Note:** If you want to terminate the set switching times prematurely, press until the default display is shown (see page 12).
6. until the required part of the week or day appears.
7. to confirm.
8. to select the time phase. The relevant time phase is represented by a number (1, 2, 3 or 4).
9. to confirm.
10. for the start point of the time phase.
11. to confirm.
12. for the end point of the time phase.
13. to confirm.
14. To adjust the beginning and end of additional time phases, proceed as described in steps 9 to 14.
15. until the default display is shown.

## Setting a Time Program *(continued)*

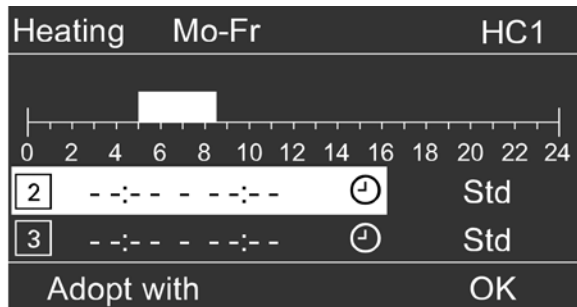

### Deleting time phases

Press the following keys if you want to delete a time phase:

1. Proceed as described in points 1 to 11 of chapter "Setting switching times".
2. **OK** until the end point of the selected time phase is displayed.
3. **▲/▼** until "--:--" is displayed for the end point.  
**Note:** "--:--" appears if the start and end time are the same.
4. **OK** to confirm.
5. **↩** until the default display is shown.

### Restoring time phases to their factory settings

If you want to restore all time phases to their factory settings, press the following keys:

1. **≡** for "Extended menu".
2. **▲/▼** to select "Settings".
3. **OK** to confirm.
4. **▲/▼** for "Standard setting".
5. **OK** to confirm.
6. **▲/▼** for "Heating".
7. **OK** to confirm.
8. **⏪/⏩** to select "Heating circuit 1" (HC1), "Heating circuit 2" (HC2), "Heating circuit 3" (HC3) or "Heating circuit 4" (HC4).
9. **▲/▼** to select "Yes".
10. **OK** to confirm.
11. **↩** until the default display is shown.

## Changing the Heating Curve

- If the room temperature does not meet your requirements for a prolonged period of time you can alter the heating characteristics.
- You influence the heating characteristics by changing the slope and shift of the heating curve. For more information regarding the heating curve, see page 21.
- Please observe the modified heating characteristics over several days (if possible, wait for a major change in the weather) before making further adjustments.

## Changing the Heating Curve *(continued)*

### Changing slope and shift

For assistance, use the following table.

Heating characteristics	Action	Example				
The living space is too cold during winter.	Adjust the heating curve slope to the next highest value (e.g. 1.5).	<table border="1"> <tr> <td>Slope</td> <td>1.5</td> </tr> <tr> <td>Level</td> <td>0 K</td> </tr> </table>	Slope	1.5	Level	0 K
Slope	1.5					
Level	0 K					
The living space is too hot during winter.	Adjust the heating curve slope to the next lowest value (e.g. 1.3).	<table border="1"> <tr> <td>Slope</td> <td>1.3</td> </tr> <tr> <td>Level</td> <td>0 K</td> </tr> </table>	Slope	1.3	Level	0 K
Slope	1.3					
Level	0 K					
The living space is too cold during spring/autumn and during winter.	Adjust the heating curve shift to a higher value (e.g. +3).	<table border="1"> <tr> <td>Slope</td> <td>1.4</td> </tr> <tr> <td>Level</td> <td>3 K</td> </tr> </table>	Slope	1.4	Level	3 K
Slope	1.4					
Level	3 K					
The living space is too hot during spring/autumn and during winter.	Adjust the heating curve shift to a lower value (e.g. -3).	<table border="1"> <tr> <td>Slope</td> <td>1.4</td> </tr> <tr> <td>Level</td> <td>-3 K</td> </tr> </table>	Slope	1.4	Level	-3 K
Slope	1.4					
Level	-3 K					
The living space is too cold during spring/autumn, but warm enough during winter.	Adjust the heating curve slope to the next lower value and the shift to a higher value.	<table border="1"> <tr> <td>Slope</td> <td>1.3</td> </tr> <tr> <td>Level</td> <td>3 K</td> </tr> </table>	Slope	1.3	Level	3 K
Slope	1.3					
Level	3 K					
The living space is too hot during spring/autumn, but warm enough during winter.	Set the heating curve slope to the next higher value and the shift to a lower value.	<table border="1"> <tr> <td>Slope</td> <td>1.5</td> </tr> <tr> <td>Level</td> <td>-3 K</td> </tr> </table>	Slope	1.5	Level	-3 K
Slope	1.5					
Level	-3 K					

Press the following keys:

1. for "Extended menu".
2. to select "Heating".
3. to confirm.
4. to select "Heating circuit 1" (HC1), "Heating circuit 2" (HC2), "Heating circuit 3" (HC3) or "Heating circuit 4" (HC4).
5. for "Heating curve".
6. to confirm.
7. for "Slope" or "Shift".
8. to confirm.
9. for the required value.
10. to confirm.
11. until the default display is shown.

**Note:** Setting the slope or shift too high or too low will not result in damage to your heating system.

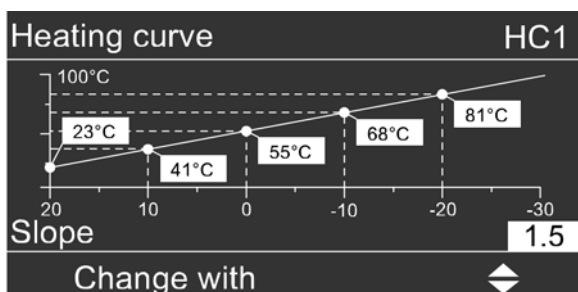

**Changing the Heating Curve** *(continued)*

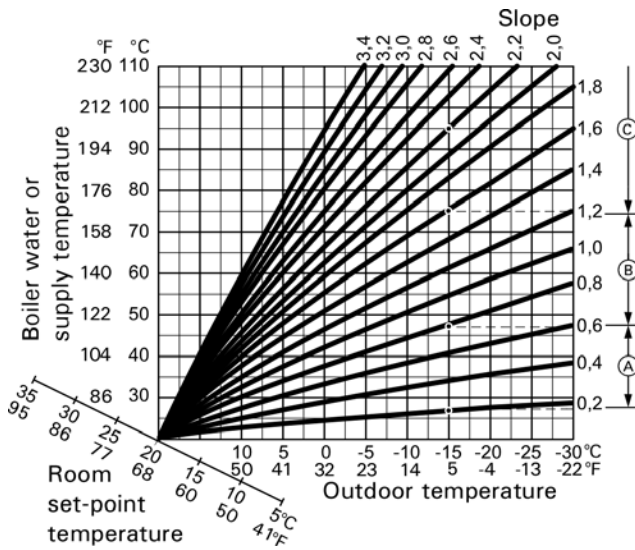

- Heating curves illustrate the relationship between the outdoor temperature and the system temperature. To put it simply: The lower the outdoor temperature, the higher the system temperature. The heating curves shown apply with the following settings:
- Heating curve shift = 0  
A different value for shift shows a curve which is offset in parallel to the vertical.
- Standard room temperature = approx. 68°F (20°C)  
In the factory set condition, the slope is set to 1.4 and the shift to 0.

Example:

For outdoor temperature 5°F (-15°C):

- (A) Underfloor heating system, slope 0.2 to 0.8
- (B) Low temperature heating system, slope 0.8 to 1.6
- (C) Heating system with a boiler water temperature in excess of 167°F (75°C), slope 1.6 to 2.0

**Stopping Central Heating**

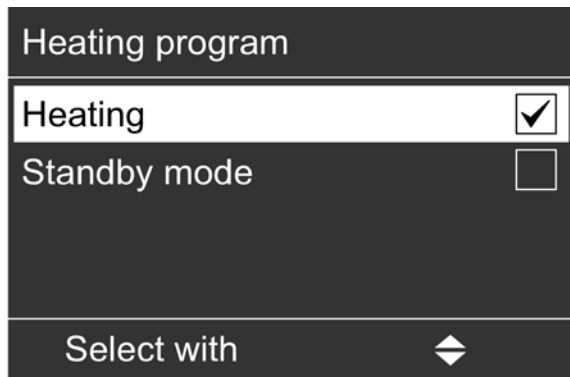

Press the following keys in the standard menu:

1. ▲/▼ for "Heating"
2. Ⓞ to confirm.
3. ⬅/➡ to select "Heating circuit 1" (HC1), "Heating circuit 2" (HC2), "Heating circuit 3" (HC3) or "Heating circuit 4" (HC4).
4. ▲/▼ for "Operating program".
5. Ⓞ to confirm.
6. ▲/▼ for "Standby mode"
7. Ⓞ to confirm. The display briefly shows "Standby mode".
8. ↶ until the default display is shown.

## Selecting Party Mode

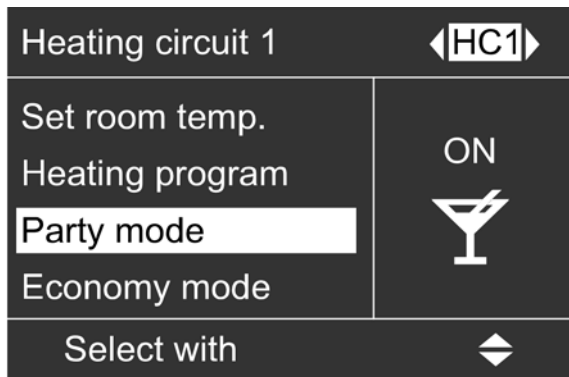

With this comfort function, you can change the room temperature of a heating circuit for a few hours, e.g. if guests stay longer in the evening. You do not have to change any existing control settings.

- The rooms are heated to the required temperature.

Press the following keys in the standard menu:

1. ▲/▼ for "Heating".
2. to confirm.
3. to select "Heating circuit 1" (HC1), "Heating circuit 2" (HC2), "Heating circuit 3" (HC3) or "Heating circuit 4" (HC4).
4. ▲/▼ for "Party mode".
5. to confirm.  
The room temperature during party mode is shown in the display.
6. ▲/▼ for the required temperature, if you want to change it.
7. to confirm.  
"Adopted" appears briefly in the dialogue line of the display. "On" appears on the right-hand side of the display in the following menu.

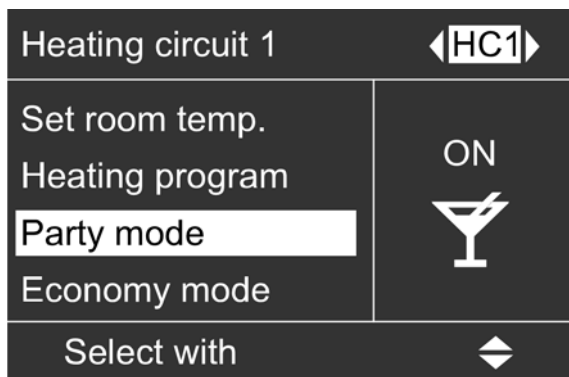

### Ending party mode

Party mode ends automatically with the next changeover to central heating with standard room temperature, but no later than after 8 hours.

If you want to terminate party mode prematurely, press the following keys in the standard menu:

1. ▲/▼ for "Heating".
2. to confirm.
3. to select "Heating circuit 1" (HC1), "Heating circuit 2" (HC2), "Heating circuit 3" (HC3) or "Heating circuit 4" (HC4).
4. ▲/▼ for "Party mode".
5. to confirm.  
"Off" appears briefly on the dialogue line of the display. "Off" appears on the right-hand side of the display in the following menu.



## Selecting Economy Mode

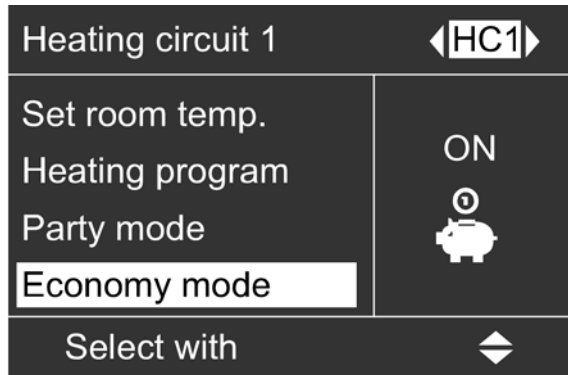

To save energy, you can reduce the room temperature in standard heating mode, for example, if you leave the house for a few hours.

### Setting economy mode

In economy mode, the standard room temperature will be reduced automatically.

Press the following keys in the standard menu:

1. ▲/▼ for "Heating".
2. Ⓚ to confirm.
3. ◀/▶ to select "Heating circuit 1" (HC1), "Heating circuit 2" (HC2), "Heating circuit 3" (HC3) or "Heating circuit 4" (HC4).
4. ▲/▼ for "Economy mode".
5. Ⓚ to confirm.  
"Economy mode On" appears briefly in the display.  
"On" appears on the right-hand side of the display in the following menu.

### Terminating economy mode

Economy mode ends automatically the next time the system changes over to central heating with standard room temperature.

If you want to terminate economy mode prematurely, press the following keys in the standard menu:

1. ▲/▼ for "Heating".
2. Ⓚ to confirm.
3. ◀/▶ to select "Heating circuit 1" (HC1), "Heating circuit 2" (HC2), "Heating circuit 3" (HC3) or "Heating circuit 4" (HC4).
4. ▲/▼ for "Economy mode".
5. Ⓚ to confirm. In the display "Economy mode Off" appears briefly. "Off" appears on the right-hand side of the display in the following menu.

## Selecting the Holiday Program

Holiday program	HC1
Departure date:	
Date	Tu 25.02.2014
Return date:	
Date	We 26.02.2014
Change with	◀▶















To save energy, for example during long holiday absences, you can enable the holiday program.

### Setting a holiday program

The holiday program starts at 12:00 am (00:00 h) the day after the departure date. The holiday program ends at 12:00 am (00:00 h) on the day of your return. In other words, the set switching times will be active on the day of your departure and the day of your return.

**Note:** The control unit is set so that the holiday program applies to all heating circuits and there is no DHW heating. If you want to change this, contact your heating contractor.

Press the following keys:











1.  for "Extended menu".
2.  to select "Heating".
3.  to confirm.
4.  to select "Heating circuit 1" (HC1), "Heating circuit 2" (HC2), "Heating circuit 3" (HC3) or "Heating circuit 4" (HC4).
5.  for "Holiday program".
6.  to confirm; the current date "Departure date" and the following date "Return date" are displayed.
7.  for departure date.  
If you want to terminate the set holiday program prematurely, press  until the default display is shown (see page 12).
8.  to confirm.
9.  to set the required date.
10.  to confirm.  
"Adopted" appears briefly in the display.
11.  for return date.
12.  to confirm.
13.  to set the required date.
14.  to confirm.  
"Adopted" appears briefly in the dialogue line of the display.

## Selecting the Holiday Program *(continued)*

### Terminating the holiday program









The holiday program terminates automatically on the day of return.

If you want to terminate the holiday program prematurely, press the following keys:

1.  for "Extended menu".
2.  to select "Heating".
3.  to confirm.
4.  to select "Heating circuit 1" (HC1), "Heating circuit 2" (HC2), "Heating circuit 3" (HC3) or "Heating circuit 4" (HC4).
5.  for "Holiday program".
6.  to confirm.
7.  for "Delete program".
8.  to confirm.
9.  for "Yes".
10.  to confirm. "Adopted" appears briefly in the dialogue line of the display.
11.  until the default display is shown (see page 12).

### Changing set holiday program

If you wish to change a set holiday program, press the following keys:

1.  for "Extended menu".
2.  to select "Heating".
3.  to confirm.
4.  to select "Heating circuit 1" (HC1), "Heating circuit 2" (HC2), "Heating circuit 3" (HC3) or "Heating circuit 4" (HC4).
5.  for "Holiday program".
6.  to confirm.
7.  for "Change?"
8.  to confirm.
9. To enter the new data, follow steps 7 to 14 in chapter "Setting the holiday program" from page 26.

## Required Settings

If you want DHW heating, check the following points:

- Have you set the required set DHW temperature?  
For settings, see page 28.
- Have you set the correct operating program?  
For settings, see page 28.
- Have you set the required time program?  
For settings, see page 29.

## Setting the DHW Temperature

Press the following keys in the standard menu:

1. ▲/▼ for "DHW"
2. Ⓚ to confirm.
3. ▲/▼ for "Set temperature".
4. Ⓚ to confirm.
5. ▲/▼ for the required temperature.
6. Ⓚ to confirm. "Adopted" appears briefly in the dialogue line of the display.
7. ↶ until the default display is shown (see page 12).

## Setting the Operating Program

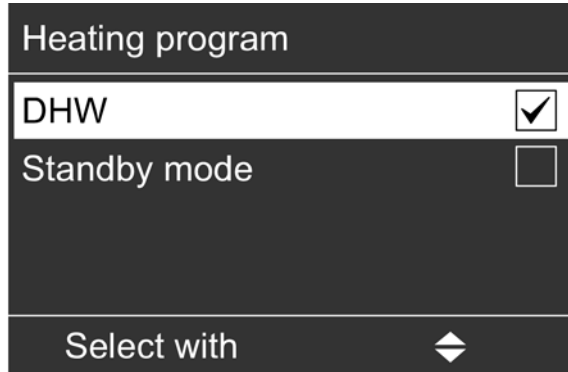

Press the following keys in the standard menu:

1. ▲/▼ for "DHW".
2. Ⓚ to confirm.
3. ▲/▼ for "Operating program".
4. Ⓚ to confirm.
5. ▲/▼ for "DHW" or "Standby mode".
6. Ⓚ to confirm.
7. ↶ until the default display is shown.

## Setting a Time Program

When DHW heating is enabled for the heating circuit depends on the settings of the switching times for the respective day (4 possible time phases).

- The time program for DHW heating is made up of time phases. A time phase from 6:00 to 10:00 pm (06:00 to 22:00 h) every day is set at the factory.
- Automatic mode is set at the factory for DHW heating.
- If you don't want automatic mode, you can select up to 4 individual time phases per day for DHW heating. For each time phase you set the start and end points.
- In the "Extended menu", you can call up the current time program under "Information" (see page 40).  
Settings in the extended menu:

1. for "Extended menu".
2. for "DHW"
3. to confirm.
4. for "DHW time program"
5. to confirm.
6. for "Individual"
7. to confirm.
8. to select the required part of the week or day.
9. to confirm.
10. for selecting the time phase 1, 2, 3 or 4.
11. to confirm.
12. to set the start point.
13. to confirm.
14. to set the end point.
15. to confirm.

Example shown:

- Time program for Monday to Friday ("Mo-Fr")
- Time phase 1: from 4:30 am to 6:30 am (04:30 to 06:30 h)
- Time phase 2: from 3:30 pm to 8:30 pm (15:30 to 20:30 h)

Example:

You want to set the same time program for every day except Monday:

Select the period "Monday–Sunday" and set the time program.

Then select "Monday" and set the time program for this.

**Note:** If you want to terminate the setting process prematurely, keep pressing until the required display appears.

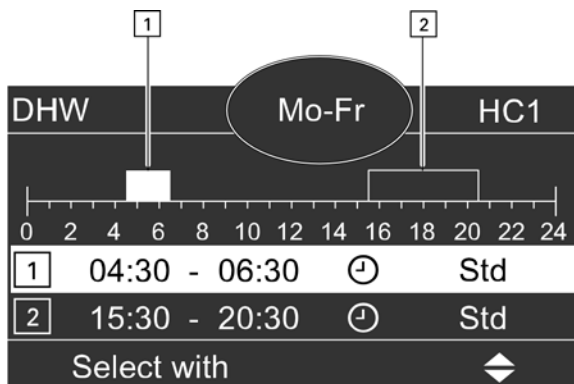

## Setting a Time Program *(continued)*

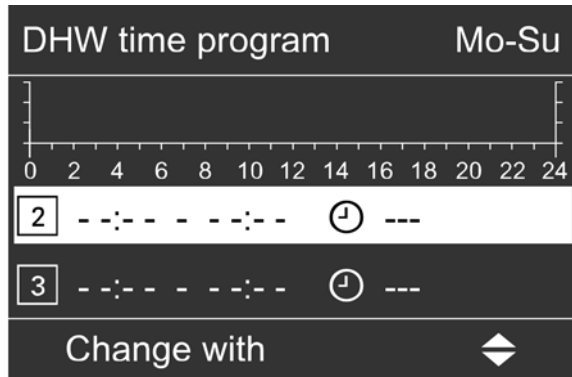

### Deleting time phases

To delete a time phase, press the following keys:

1. Proceed as described in points 1 to 12 of chapter "Setting a time program".
2. **OK** until the end point of the selected time phase is displayed.
3. **▲/▼** until "- : - -" is displayed for the end point.
4. **OK** to confirm.
5. **↶** until the default display is shown.

### Restoring time phases to their factory settings

If you want to restore all DHW heating time phases to their factory settings, press the following keys:

1. **≡** for "Extended menu".
2. **▲/▼** for "Settings".
3. **OK** to confirm.
4. **▲/▼** for "Standard setting".
5. **OK** to confirm.
6. **▲/▼** for "DHW".
7. **OK** to confirm.
8. **▲/▼** for "Yes".
9. **OK** to confirm.
10. **↶** until the default display is shown (see page 12).

## Stopping DHW Heating

Press the following keys in the standard menu:

1. **▲/▼** for "DHW".
2. **OK** to confirm.
3. **▲/▼** for "Operating program".
4. **OK** to confirm.
5. **▲/▼** for "Standby mode".
6. **OK** to confirm.

## Setting an Operating Program

There are 3 operating programs available for controlling the heating water temperatures in the heating water buffer tank:

- **“Automatic system”**

In automatic mode, the average set temperature of the heating water buffer tank is determined automatically via the selected heating curve of the buffer. A set value is determined subject to the outdoor temperature and the selected values for shift and slope.







- **“Manual”**

In manual mode, you can specify a fixed value for the average set temperature of the heating water buffer tank. You can enter this set value in the “Buffer” menu when manual mode is selected. For a description.







- **“Off”**

In this operating program, the heating water buffer tank is heated by the boiler. The boiler regulates to the set boiler water temperature. The buffer temperatures have no influence on the boiler output control.

Press the following keys to set the operating program:

1.  for “Extended menu”.
2.  for “Buffer”
3.  to confirm.
4.  for “Operating program”.
5.  to confirm.
6.  for “Automatic system”, “Manual” or “Off”.
7.  to confirm.

Enter the average set temperature of the heating water buffer tank in manual mode:

1.  for “Extended menu”.
2.  for “Buffer”
3.  to confirm.
4.  for “Set temp man mode”.  
This menu point is only available when manual mode is selected.
5.  to confirm.
6.  for the required temperature.
7.  to confirm.

**Setting a Time Program**

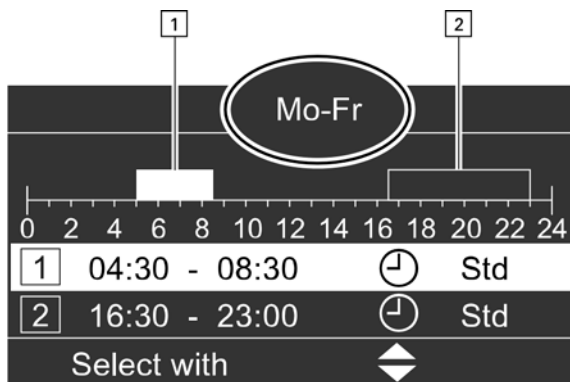
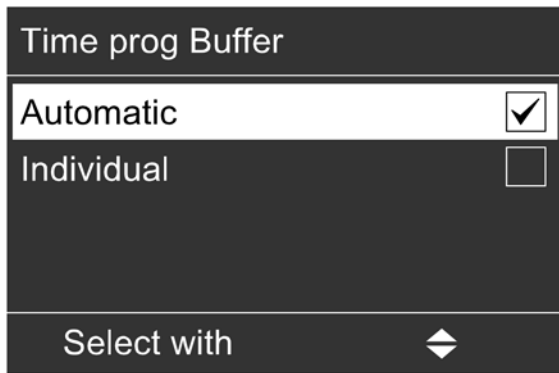

You can set these heating times by adjusting the time program for the heating water buffer tank. During the set time phases, the charging condition of the heating water buffer tank has an effect on the boiler operation.

**Note:** If you are using a solar thermal system for central heating backup, balance the charging times of the heating water buffer tank with the control unit of the solar thermal system.

- The time program for the heating water buffer tank is made up of time phases. A time phase from 6:00 am to 10:00 pm (06:00 to 22:00 h) every day is set at the factory.
- The time program for the heating water buffer tank is preset to Automatic mode at the factory. In automatic mode, the time program for the heating water buffer tank is disregarded.
- If you don't require automatic mode, you can select up to 4 individual time phases per day. For each time phase you set the start and end points.
- In the "Extended menu", you can call up the current time program under "Information" (see page 40).

Settings in the extended menu:

1. ≡: for "Extended menu".
2. ▲/▼ for "Buffer"
3. Ⓚ to confirm.
4. ▲/▼ for "Time program"
5. Ⓚ to confirm.
6. ▲/▼ for "Individual"
7. Ⓚ to confirm.
8. ▲/▼ to select the required part of the week or day.
9. Ⓚ to confirm.
10. ▲/▼ for selecting the time phase [1], [2], [3] or [4].
11. Ⓚ to confirm.
12. ▲/▼ to set the start point.
13. Ⓚ to confirm.
14. ▲/▼ to set the end point.
15. Ⓚ to confirm.

Example shown:

- Time program for Monday to Friday ("Mo-Fr")
- Time phase [1]: from 4:30 am to 8:30 am (04:30 to 08:30 h)
- Time phase [2]: from 4:30 pm to 11:00 pm (16:30 to 23:00 h)

**Deleting time phases**

To delete a time phase, press the following keys:

1. Proceed as described in points 1 to 12 of chapter "Setting a time program".
2. Ⓚ until the end point of the selected time phase is displayed.
3. ▲/▼ until "- - : - -" is displayed for the end point.
4. Ⓚ to confirm.
5. ↶ until the default display is shown.

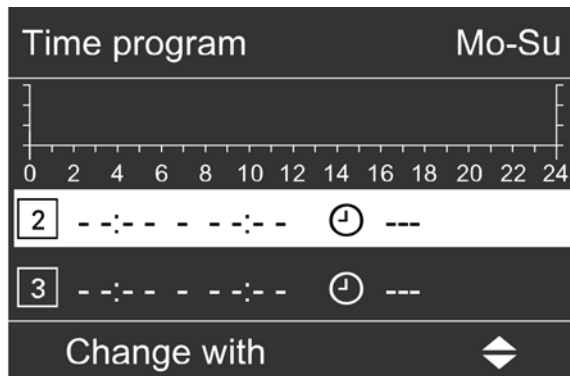



## Setting the Heating Curve

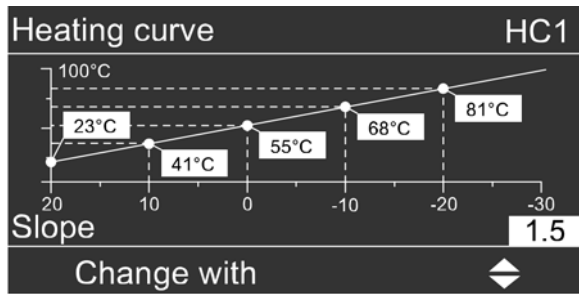

In the "Automatic system" operating program, the control unit automatically determines the average set temperature of the heating water buffer tank. It takes into account the selected heating curve and the outdoor temperature.

Press the following keys:

1. for "Extended menu".
2. to select "Buffer".
3. to confirm.
4. for "Heating curve".
5. to confirm.
6. for "Slope" or "Shift".
7. to confirm.
8. for the required value.
9. to confirm.
10. until the default display is shown.

## Blocking Times for Automatic Fuel Supply

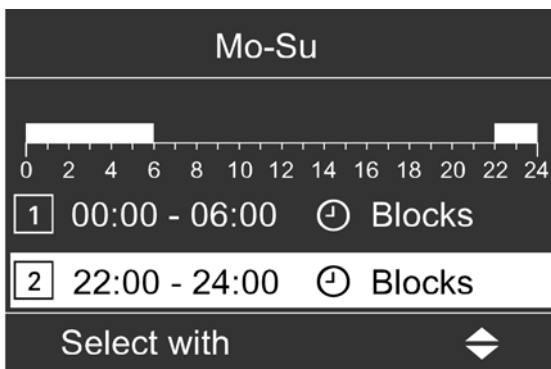
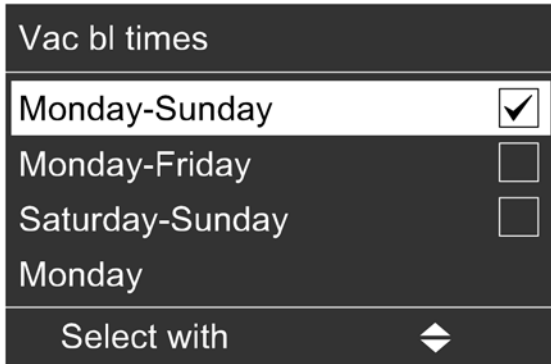

**Note:** Blocking times for pellet supply can only be set if pellets are supplied via a vacuum system. If you only want the pellet hopper to be charged at certain times, you can set the blocking times individually. Select the times so that there is sufficient fuel available during the blocking times.

### Setting blocking times

1. for "Extended menu".
2. for "Charging".
3. to confirm.
4. for "Vac mod blocking times".
5. to confirm.
 

**Note:** If you want to terminate the set supply times prematurely, press until the default display is shown (see page 14).
6. until the required part of the week or day appears.
7. to confirm.
8. to select the time phase. The relevant time phase is represented by a number (, , or ).
9. to confirm.
10. for the start point of the time phase.
11. to confirm.
12. for the end point of the time phase.
 

**Note:** Never set blocking times longer than 10 hours. Blocking times in excess of 10 hours will trigger a fault display due to fuel shortage.
13. to confirm.
14. To adjust the beginning and end of additional time phases, proceed as described in steps 10 to 15.
15. until the default display is shown (see page 12).









### Deleting time phases

Press the following keys if you want to delete a time phase:

1. Proceed as described in points 1 to 11 of chapter "Setting blocking times".
2. until the end point of the selected time phase is displayed.
3. until "--:-- --:--" is displayed for the end time. "--:-- --:--" appears if the start and end time are the same.
4. to confirm.
5. until the default display is shown (see page 12).

## Setting the Display Contrast

Press the following keys in the standard menu:











1.  for "Extended menu".
2.  for "Settings"
3.  to confirm.
4.  for "Contrast"
5.  to confirm.
6.  for the required contrast
7.  to confirm.
8.  until the default display is shown.

## Setting the Display Brightness

You would like to be able to read the text in the menu better. Change the brightness level of the "Controls" display:

You can also alter the screensaver brightness.

Press the following keys in the standard menu:

1.  for "Extended menu".
2.  for "Settings"
3.  to confirm.
4.  for "Brightness"
5.  to confirm.
6.  for "Controls" or "Screensaver"
7.  to confirm.
8.  for the required brightness
9.  to confirm.
10.  until the default display is shown.

## Naming the Heating Circuits

Example:

Name for heating circuit 1: Apartment

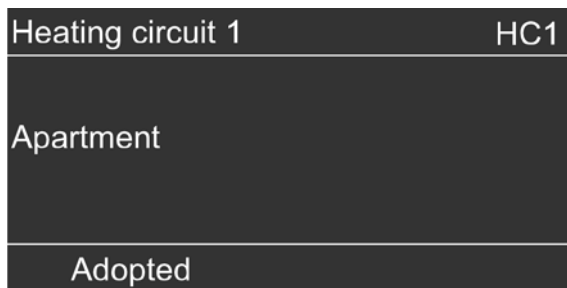
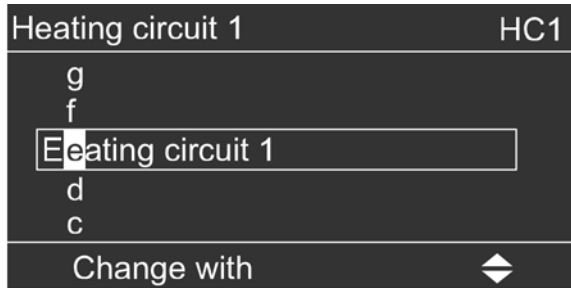

The menu shows "Apartment" for heating circuit 1.

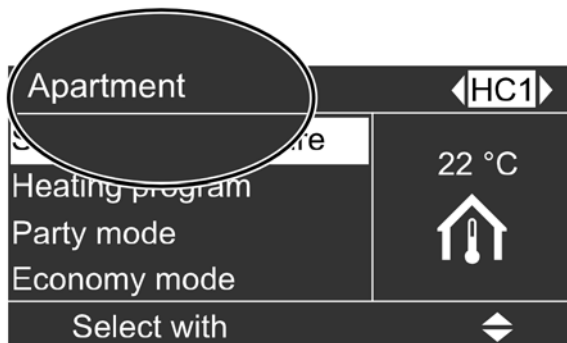

You can give heating circuits 1, 2, 3 and 4 ("HC1", "HC2", "HC3" and "HC4") individual names. The abbreviations "HC1", "HC2", "HC3" and "HC4" are retained.











Press the following keys in the standard menu:

1. for "Extended menu".
2. for "Settings"
3. to confirm.
4. for "Heating circ design"
5. to confirm.
6. to select "Heating circuit 1" (HC1), "Heating circuit 2" (HC2), "Heating circuit 3" (HC3) or "Heating circuit 4" (HC4).
7. to confirm.
8. to change the letters.
9. to select the next character.
10. to confirm.
11. until the default display is shown.

## Setting the Time and Date









The time and date are factory-set. If your heating system has been shut down for a prolonged period, you may need to reset the time and date.

Press the following keys in the standard menu:

1.  for "Extended menu".
2.  for "Settings"
3.  to confirm.
4.  for "Time / Date"
5.  to confirm.
6.  for "Time" or "Date"
7.  to confirm.
8.  for the required time or the required date.
9.  to confirm.
10.  until the default display is shown.

## Setting the Language









Press the following keys in the standard menu:

1.  for "Extended menu".
2.  for "Settings"
3.  to confirm.
4.  for "Language"
5.  to confirm.
6.  for the required language.
7.  to confirm.
8.  until the default display is shown.

## Setting the Temperature Unit (°C/°F)

Factory setting: °C









Press the following keys in the standard menu:

1.  for "Extended menu".
2.  for "Settings"
3.  to confirm.
4.  for "Temperature unit"
5.  to confirm.
6.  for the required unit.
7.  to confirm.
8.  until the default display is shown.

## Changing the Boiler Water Temperature

In the factory set condition, the boiler water temperature is set to 167°F (75°C). The temperature of the boiler water is regulated to the set value.









Press the following keys in the standard menu:

1.  for "Extended menu".
2.  for "Boiler"
3.  to confirm.
4.  for "Boiler water temp"
5.  to confirm.
6.  for the required temperature.
7.  to confirm.
8.  until the default display is shown.

## Setting the Minimum System Temperature

**Note:** This setting is only available if it has been enabled by your heating contractor in the control unit.

Select a value according to the minimum temperature you require for the heating system. When the temperature falls below this value, the boiler or the additional heat generator starts.











1.  for "Extended menu".
2.  for "Boiler"
3.  to confirm.
4.  for "Min set system temp"
5.  to confirm.
6.  for the required temperature.
7.  to confirm.
8.  until the default display is shown.

## Restoring the Factory Settings

Amongst others, the following settings and values will be reset:

- Set room temperature
- Set DHW temperature
- Time program for central heating
- Time program for DHW heating
- Time program for DHW circulation pump
- Party mode is deleted
- Economy mode is deleted
- Holiday program is deleted
- Heating curve slope and shift

You can individually restore all modified values for each heating circuit to their factory setting.

1.  for "Extended menu".
2.  for "Settings"
3.  to confirm.
4.  for "Standard settings"
5.  to confirm.
6.  for selecting the required parameter group. "General", "Heating" and "DHW" are available. Select the required heating circuit under "Heating" with  and continue.
7.  to confirm.
8.  to change "No" to "Yes"
9.  until the default display is shown.

## Scanning Fault Messages

Fault	
Outside temp sensor	34
Fault O2 probe	91
Acknowledge with	OK



Boiler water temp	
	48°C
Fault	
Boiler	
Buffer	
Heating	
Continue with	OK

If any faults have occurred in your heating system, the symbol "⚠" flashes in the display and "Fault" is shown. The heating contractor uses fault messages to quickly pinpoint the cause of your boiler's fault. This can reduce the time required to resolve the fault and therefore also your costs.

Make a note of the fault message displayed so you can advise your heating contractor accordingly. This makes preparations easier and may save extra travel expenses.

Danger due to unresolved faults in the heating system.



- If a fault occurs, shut the system down and make it safe.
- Contact your heating contractor immediately.
- Rectify the fault immediately or have a heating contractor rectify it if necessary.
- When rectifying the fault, no-one else should be present in the danger zone around the heating system.

1. You can call up the cause of the fault with .
2. Pressing  calls up information on the heating system characteristics. Tips on which measures you can take yourself before notifying your heating contractor are also displayed.
3. Make a note of the cause of the fault and the fault code next to it on the right. In the example: "Outdoor sensor 34" and "Fault O2 probe 91". This enables the heating contractor to be better prepared for the service call and may save additional travelling costs.

4. If you want to acknowledge the fault message, follow the instructions in the menu. The fault message is applied into the menu.

- Note:**
- If you have connected alarm equipment to indicate fault messages (e.g. a buzzer), this alarm equipment is deactivated when the fault message is acknowledged
  - If the fault can only be rectified at a later date, the fault message is displayed again the next day and the alarm is switched on again.

### Calling up an acknowledged fault message in the standard menu

1.  for "Fault"
2.  to confirm.

## Scanning Information

You can call up information in the standard menu and in the extended menu. They differ in the extent of the information displayed.

If you call up the "Heating" sub-menu, you can request information on the required heating circuit via "◀/▶".

### Calling up information in the standard menu

**Note:** Subject to system version, different information will be available.

Press the following keys in the standard menu:

1. ▲/▼ for "Information"
2. Ⓚ to confirm. The following scanning options are now available:

Calling up information in the "Standard menu":

- Outdoor temperature
- "Heating" sub-menu:
  - Set supply temperature
  - Actual supply temperature
  - Heating circuit pump
  - Valve
  - Operating program
  - Operating status
- "DHW" sub-menu
  - Set DHW temperature
  - Actual DHW temperature
  - Set return temperature
  - Actual return temperature
  - Pump
  - Valve
  - Operating program
  - Operating status
- "Solar" sub-menu
  - DHW solar
  - Collector temperature
  - Current solar circuit pump
  - Solar circuit pump hours run
  - Reheating suppression enabled

### Calling up information in the extended menu

Press the following keys:

1. ≡ for displaying the extended menu
2. ▲/▼ for "Information"
3. Ⓚ to confirm. The following scanning options are now available:

Calling up information in the "Extended menu":

- "General" sub-menu:
  - Outdoor temperature
  - Set system temperature
  - Enable additional boiler
  - Time
  - Date
- "Boiler" sub-menu:
  - Boiler water temperature
  - Boiler return
  - Flue gas temperature
  - Flue gas residual oxygen
  - Primary air damper
  - Secondary air damper
  - Boiler circuit pump
  - Boiler valve
  - Flue gas fan
  - Feed screw conveyor
  - Fuel consumption
  - Ash box
  - Boiler start
  - Hours run
- "Heating" sub-menu:
  - Operating program
  - Operating status
  - Time program
  - Set room temperature
  - Set reduced room temperature
  - Set supply temperature
  - Actual supply temperature
  - Slope
  - Shift
  - Heating circuit pump
  - Valve
- "DHW" sub-menu
  - Operating program
  - Status
  - DHW time program
  - Set DHW temperature
  - Actual DHW temperature
  - Set return temperature
  - Actual return temperature
  - Pump
  - Valve



## Scanning Information *(continued)*

### Calling up temperatures

You can scan temperatures in the standard menu and in the extended menu. The range of displayed values is wider in the extended menu. We therefore recommend calling up temperatures via the extended menu.

#### Calling up temperatures in the standard menu

Press the following keys:

1. ▲/▼ for "Information"
2.  to confirm.
3. ▲/▼ for "Outdoor temperature", "Heating" or "DHW".

The overview below shows the temperatures displayed in the "Heating" and "DHW" submenus.

"Heating" sub-menu:

- Set supply temperature
- Actual supply temperature

"DHW" sub-menu:

- Set DHW temperature
- Actual DHW temperature
- Set return temperature
- Actual return temperature

#### Scanning the heating water buffer tank temperatures in the standard menu

Press the following keys:



1. ▲/▼ for "Buffer"
2.  to confirm.
3. ▲/▼ to display the required temperature

The following temperatures can be called up in the "Buffer" menu:

- Set buffer
- Buffer average
- Buffer sensors

### Calling up temperatures in the extended menu

Press the following keys:

1.  for "Extended menu".
2. ▲/▼ for "Information"
3.  to confirm.
4. ▲/▼ for "General", "Boiler", "Heating" or "DHW".  
The following overviews show the temperatures displayed in the sub-menus.
5.  to confirm.

Temperatures in "General" sub-menu:

- Outdoor temperature
- Set system temperature

Temperatures in "Boiler" sub-menu:

- Boiler water temperature
- Boiler return
- Flue gas temperature

Temperatures in "Heating" sub-menu:

- Set room temperature
- Set reduced room temperature
- Set supply temperature
- Actual supply temperature

Temperature in "DHW" sub-menu:

- Set DHW temperature
- Actual DHW temperature
- Set return temperature
- Actual return temperature

## Shutting Down the Heating System for an Extended Period

You can switch your heating system off if you do not intend to use it. We recommend you contact your heating contractor before and after shutting down for longer periods.

Your heating contractor can then take suitable steps, such as frost protection for the system or heating surface preservation, as required.

**Note:** No special measures are required when shutting down the system on a temporary basis.

## Shutdown

1. Switch off the boiler by pressing "START/STOP" on the control unit.
2. Wait until the run-on time has passed and let the boiler cool down.
3. Perform all work described in the overview of chapter "Maintenance" starting on page 44.
4. When there is a risk of frost, drain the boiler, observing the instructions issued by your heating system installer or ask them to charge the system with antifreeze.

**Rooms are Too Cold**

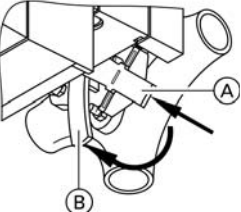
Cause	Remedy
Central heating is off.	
Control unit incorrectly set.	Check the settings and correct if required: <ul style="list-style-type: none"> <li>■ The heating circuit must be switched on (see page 23)</li> <li>■ Room temperature (see page 18)</li> <li>■ Time (see page 37)</li> <li>■ Switching times (see page 19)</li> </ul>
Control unit fault: "Fault" is displayed and the red fault indicator flashes	Check the type of fault (see page 39) and notify your heating contractor.
The heating circuit pump is not working.	Contact your heating contractor.
Heating circuit with mixing valve: Mixing valve motor faulty	Unlock motor lever (A) and manually adjust mixing valve lever (B) (e.g. to "5"). Contact your local heating contractor. 

**Rooms are Too Hot**

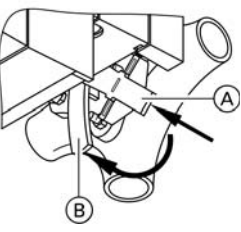
Cause	Remedy
Control unit incorrectly set.	Check the settings and correct if required: <ul style="list-style-type: none"> <li>■ The heating circuit must be on (see page 23).</li> <li>■ Room temperature (see page 18)</li> <li>■ Time (see page 37)</li> <li>■ Switching times (see page 19)</li> </ul>
Control unit fault or outdoor temperature sensor/ boiler water temperature sensor faulty: "Fault" will be displayed; the red fault indicator flashes.	Check the type of fault (see page 39) and notify your local heating contractor.
Heating circuit with mixing valve: Mixing valve motor faulty	Unhook motorized lever (A) and manually adjust mixing valve lever (B) (to "5" for example). Notify your heating contractor. 

## There is No Hot Water

Cause	Remedy
Control unit incorrectly set.	Check the settings and correct if required: <ul style="list-style-type: none"> <li>■ DHW heating must be on (see page 28)</li> <li>■ DHW temperature (see page 28)</li> <li>■ Time (see page 37)</li> <li>■ Switching times (see page 29)</li> </ul>
DHW tank is cold.	Check the DHW heating times (see page 29) Check the set DHW temperature (see page 28) If the heating times are OK: Check the temperature of the DHW tank. If it is too low: Notify your heating contractor.
The DHW tank pump is not running.	Check the heating times. If the pump is supposed to be running according to the times set in the control unit: Notify your heating contractor.
Mixing valve faulty	Notify your heating contractor.

## The DHW is Too Hot

Cause	Remedy
Control unit incorrectly set.	Check and correct the DHW temperature if required (see page 28).
Sensor fault	Notify your heating contractor.

## “Fault” is Shown on the Display

Cause	Remedy
Heating system fault	Check the type of fault (see page 39) and notify your heating contractor.

## “Solar Risk of Overheating” Appears on the Display

Cause	Remedy
No more heat can be transferred from a connected solar thermal system (e.g. solar tank is full) and the collectors are overheating.	This message is for information only and disappears once the solar thermal system has cooled down again.

## Inspection/Cleaning/Maintenance

### Cleaning

You can clean the surface of the programming unit with a microfiber cloth. All equipment can be cleaned with a commercially available domestic cleaning agent (non-scouring).

### Inspection and maintenance

Inspection and maintenance of your heating system is recommended.

Regular maintenance ensures trouble free, energy efficient, environmentally responsible and safe heating. Your heating system must be serviced by an authorised contractor at least every 2 years. For this, we advise you to arrange an inspection and maintenance contract with your local heating contractor.

### Boiler

Increasing boiler contamination raises the flue gas temperature and thereby increases energy losses. For that reason, all boilers should be cleaned annually.

### DHW tank

Maintenance and cleaning should be carried out no later than two years after commissioning and thereafter as required.

Only a qualified heating contractor should clean the inside of a DHW tank and the DHW connections. Refill any water treatment equipment (e.g. water softener or water filtration unit) on time, if such equipment is installed in the cold water supply of the DHW tank. Observe the manufacturer's instructions.

### Safety valve (DHW tank)

The safety valve function should be checked every six months by venting, either by the system user or the local heating contractor. The valve seat may become contaminated (see the valve manufacturer's instructions).

### Potable water filter (if installed)

To maintain high hygienic standards, proceed as follows:

- Replace filter element on non-back flushing filters every six months (visual inspection every two months).
- On back flushing filters, back flush every two months.

## Replacing Fuses

### **WARNING**

Contact with 'live' components of the control unit can lead to fatal injury due to electric shock. Only a heating contractor may replace fuses/MCBs.

## Overview of Maintenance and Cleaning Work in the Boiler

**! WARNING**

Hot surfaces can lead to serious injuries.  
Only open the boiler after it has cooled down.

**! WARNING**

Breathing in ash or pellet dust is detrimental to health.  
Wear a (Noish N95) dust mask to protect your respiratory tract.

Have a heating contractor clean the interior of the boiler once a year.

**! CAUTION**

During maintenance and cleaning work, and when manipulating the ash box, there is a risk of fire and burns due to hot parts and ash.

- Wear suitable safety gloves.
- Only dispose of the hot ash in fireproof containers with covers.

Vitoligno 300-C	System user	Heating contractor
<b>After 6,600 to 8,800 lb. (3,000 to 4,000 kg) of pellets consumed or at least once per year</b>		
Empty ash box (see page 46).	X	--
Check the system pressure. Minimum system pressure: 14.5 psi (1.0 bar)	X	--
<b>After 33,000 lb. (15,000 kg) of pellets consumed or at least once per year</b>		
Check all installed position switches	--	X
Remove the flue ash from the chimney	--	X
Clean the flue pipe	--	X
Clean the secondary heating surfaces	--	X
Clean the flue gas collector chamber	--	X
Clean the Lambda probe with a soft brush	--	X
Clean the flue gas temperature sensor	--	X
Clean flue gas fan	--	X
Clean the combustion chamber	--	X
Clean the reversing chamber	--	X
Clean the finned grate	--	X
Clean the ignition element and ignition pipe	--	X
Clean the ash chamber and ash removal parts	--	X
Clean the pellet sensor in the pellet hopper with a soft brush	--	X
Clean the intake grille in the pellet hopper with a vacuum cleaner	--	X
Clean the vacuum module with a vacuum cleaner	--	X
Check all gaskets on the covers and replace if necessary	--	X
<b>After 66,000 lb. (30,000 kg) of pellets consumed or at least once every 3 years</b>		
Maintenance of moving parts (drive chains, shafts, friction bearings, cogs, etc.)	--	X
<b>Every 5 years</b>		
Replace the battery inside the control unit.	--	X

## Emptying the Ash Box

**Note:** Do not isolate the boiler from the power supply at the mains isolator, as then the ash box would not be detected by the control unit and no messages would appear on the control unit display.

**Note:** If the ash box was emptied without a message having been displayed on the control unit, reset the ash fill level at the control unit:

☰: for "Extended menu" ▶ "Information" ▶ "Reset data" select "Ash box" ▶ "Reset data" ▶ "Yes"- "No" ▶  to confirm.

### CAUTION

Breathing in ash or pellet dust is detrimental to health. Wear a dust mask to protect your respiratory tract.

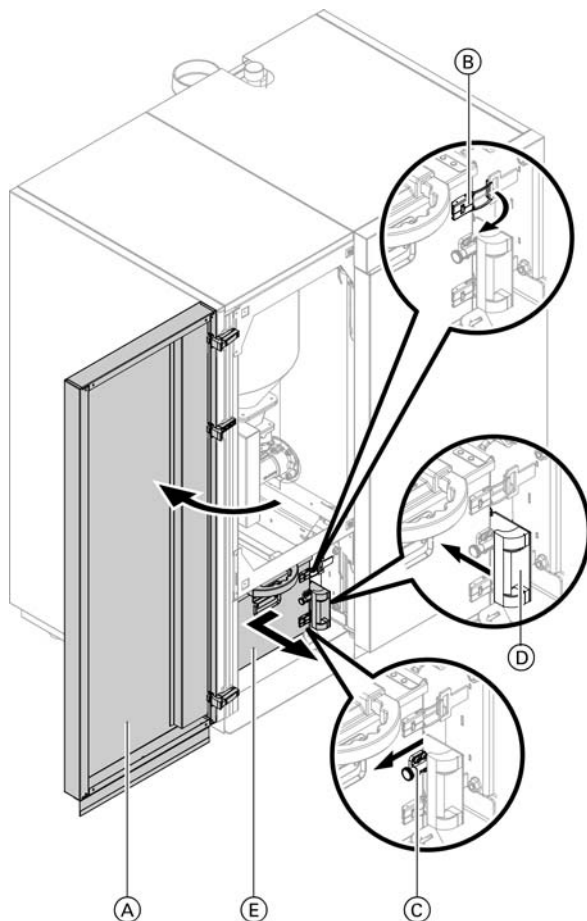

1. Switch the boiler off at the control unit with the "START/STOP" button. Wait until "Buffer drawing" or "Residual heat utilisation" is shown on the display.
2. Only for pellet supply via vacuum system: Open left hand front panel (door) (A).
3. Open tensioning toggles (B) by pushing down on the tensioning toggle clip. Push the ash box a little to the left.
4. Extract locking bolt (C). Push ash partition (D) back as far as it will go.
5. Pull out ash box (E) towards the front.  
**Note:** The telescopic handle can be pulled out to various lengths.
6. Empty the ash box. For this remove the ash box cover.
7. Remove residues of ash from the base plate.
8. Reseal the ash box with its cover.
9. Proceed in reverse order to re-insert the ash box and close the boiler.  
**Note:** Observe before closing the boiler that ash separator (D) must be opened again.
10. Switch the boiler back on at the control unit with the "START/STOP" button.

## Terminology

### Setback mode (reduced heating mode)

See "Reduced heating mode".

### Heating program

With the heating program you determine whether you heat your rooms and DHW, or only heat DHW or whether you shut down your heating system with frost protection monitoring.

You can select the following heating programs:

#### ■ "Heating and DHW"

The rooms are heated and DHW is provided (winter mode).

#### ■ "Only DHW"

DHW is provided but there is no central heating (summer mode).

#### ■ "Standby mode"

Frost protection for the boiler and the DHW tank is enabled, no central heating, no DHW heating.

**Note:** No heating program is available for central heating without DHW heating. When you want central heating, hot water is generally also required (winter mode). If you do want just central heating, select the heating program "Heating and DHW" and set the DHW temperature to 50°F (10°C) (see page 28). This means that you will not heat DHW unnecessarily but the DHW tank is protected against frost.

### Operating status

In the heating program "Heating and DHW", the operating status changes from "Standard heating mode" (see page 18) to the operating status "Reduced heating mode" (see page 18) and vice versa. The times for the operating status change are defined when the time program is set.

### Extension kit for heating circuit with mixing valve

Assembly (accessory) for controlling a heating circuit with mixing valves. See "Mixing valves".

### Mixing Valve

A mixing valve mixes the water heated in the boiler with the cooled water returning from the heating circuit. The water, heated to the right temperature in line with demand, is factory set to the heating circuit by the heating circuit pump. The control unit adjusts the heating circuit supply temperature via the mixing valve to the various conditions, e.g. different outdoor temperature.

### Heating circuit pump

Circulation pump for the circulation of the heating water in the heating circuit.

**Terminology** *(continued)*

**Heating curve**

Heating curves illustrate the relationship between the outdoor temperature, room temperature (set value) and boiler water or (heating circuit) supply temperature. The lower the outdoor temperature, the higher the boiler water or (heating circuit) supply temperature. In order to guarantee sufficient heat and minimum fuel consumption at any outdoor temperature, the conditions of your building and your heating system must be taken into consideration. The heating curve is set by your heating contractor for this purpose.

**Note:** If your heating system includes heating circuits with mixing valves, then the supply temperature for the heating circuit without mixing valves is higher by a selected differential than the supply temperature for the heating circuits with mixing valves.

The illustrated heating curves apply with the following settings:

- Heating curve shift = 0
- Standard room temperature (set value) = 68°F (20°C)

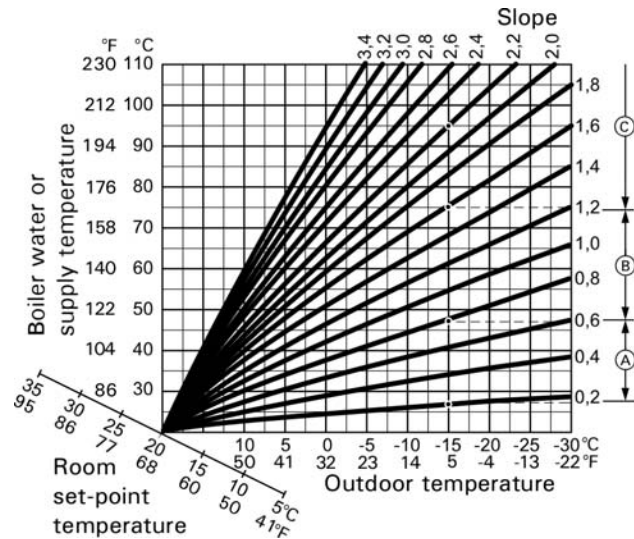

**Example:**

For outdoor temperature 5°F (-15°C):

- (A) Underfloor heating system, slope 0.2 to 0.8
- (B) Low temperature heating system, slope 0.8 to 1.6
- (C) Heating system with a boiler water temperature in excess of 167°F (75°C), slope 1.6 to 2.0

**Heating circuit**

A heating circuit is a sealed circuit between the boiler and radiators, in which the heating water circulates. A heating system may comprise several heating circuits. For example, one heating circuit for the rooms occupied by you and one heating circuit for the rooms of a separate apartment.

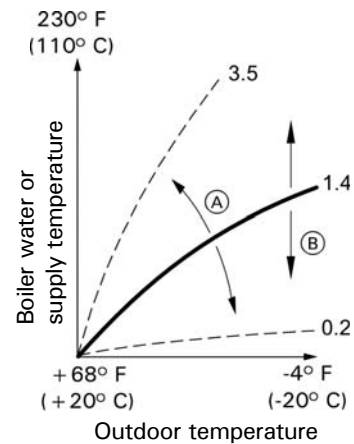

**Terminology** *(continued)*

Factory settings: Slope = 1.4 and shift = 0.

- Ⓐ Changing the slope: The steepness of the heating curve changes
- Ⓑ Changing the shift: The heating curves are shifted in parallel in a vertical direction

**Actual temperature**

Current temperature at the time of the scan; e.g. actual DHW temperature.

**Night setback**

See "Reduced heating mode".

**Standard heating mode**

When you are in the house during the day, you can heat the rooms in standard heating mode. Set the periods using the time program for central heating. During these periods, the rooms are heated to the standard room temperature.

**Standard room temperature**

When you are in the house during the day, set the standard room temperature (see page 18).

**Open flue operation**

The combustion air is drawn from the room where the boiler is installed.

**Balanced flue operation**

The combustion air is drawn from outside the building.

**Reduced heating mode**

When you are out or during the night, you can heat the rooms in reduced heating mode (setback mode). Set the periods using the time program for central heating. During these periods, the rooms are heated to a reduced room temperature.

**Terminology** *(continued)***Reduced room temperature**

When you are out or during the night, set the reduced room temperature (see page 18). See also "Reduced heating mode".

**Safety valve**

A safety device that must be installed by your heating contractor in the cold water pipe. The safety valve opens automatically to prevent excess pressure in the DHW tank.

**Solar circuit pump**

In conjunction with solar thermal systems. The solar circuit pump delivers the cooled heat transfer medium from the DHW tank indirect coil to the collectors.

**Set temperature**

Default temperature that should be reached; e.g. set DHW temperature.

**Summer mode**

Heating program "Only DHW".

At warmer times of the year, i.e. when rooms do not have to be heated, you can disable heating mode. The boiler remains enabled for DHW heating.

**Tank primary pump**

Circulation pump for heating the DHW in the DHW tank.

**Drinking water filter**

A device that removes solids from the water. The drinking water filter is installed in the cold water pipe upstream of the DHW tank or the instantaneous water heater.

**Weather-compensated mode**

In weather-compensated mode, the heating supply temperature is controlled according to the outdoor temperature. This means that no unnecessary heat is generated in order to heat the rooms to the set room temperature you selected.

The outdoor temperature is captured and transmitted to the control unit by a sensor fitted outside the building.

**DHW recirculation pump**

The DHW recirculation pump transports the hot water around a circuit between the DHW tank and the draw-off points (e.g. hot tap). This makes hot water available quickly at the draw-off point.

## Efficient and Clean Operation

- Your boiler can be controlled within a range of 30 to 100% of its rated heating output. To avoid unnecessary emissions in low load operation, the appliances should be operated in the middle and upper output range (adjusted to the relevant heat demand) if possible. To avoid unnecessary cycling and to ensure the longest possible runtimes, combination with a modulating room or heating controller is ideal.
- In terms of energy, a buffer tank and combination with a solar thermal system are recommended. This guarantees efficient and clean operation of your heating system.

To ensure efficient and clean operation of your heating system, please note the following:

- Only qualified and trained personnel may install and adjust the system.
- Only use the fuels specified in our operating instructions (see chapter "Ordering fuel"). This is essential for ensuring clean, efficient and reliable operation of your heating system.
- Regularly carry out the recommended maintenance and cleaning work on your system. For details, see chapter "Maintenance and repairs" in the operating instructions. This guarantees not only the operational reliability of the heating system and its safety equipment, but also its efficient and clean operation. For the best support of your heating system, we recommend taking out a maintenance contract.

## Dismantling

Have a heating contractor dismantle the boiler and the associated system components.

## General Energy Saving Tips

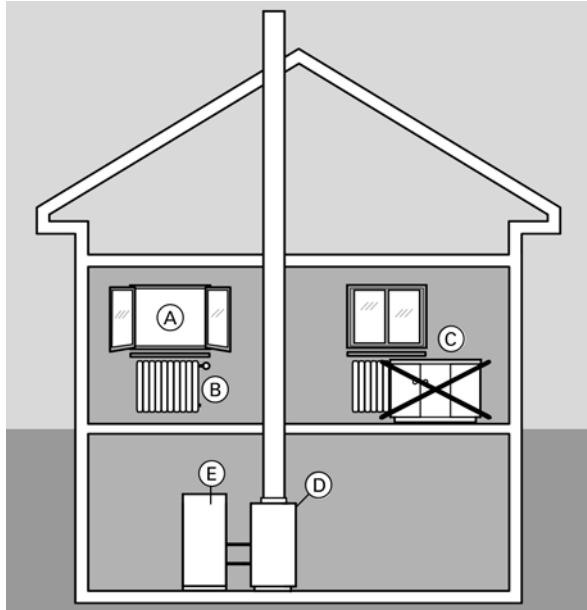

With the following steps, you can save even more energy:

- Correct ventilation/airing. Briefly open window (A) fully and at the same time close thermostatic valves (B).
- Never overheat the interior; endeavour to achieve a room temperature of 68°F (20°C); every degree of room temperature reduction saves up to 6% of your heating bills.
- At dusk, close roller shutters (if installed) on windows.
- Adjust thermostatic valves (B) correctly.
- Never cover radiators (C) or thermostatic valves (B).
- Make use of the setting options offered by remote control (D), e.g. alternating standard temperature with reduced room temperature.
- Set the DHW temperature of DHW tank (E) at control unit (D).
- Only activate the DHW circulation pump (via switching times at the control unit) when DHW is actually drawn.
- Controlled use of DHW: A shower generally uses less energy than a full bath.

Scan for  
digital copy  
of this  
document



Viessmann Manufacturing Company Inc.  
750 McMurray Road  
Waterloo, Ontario • N2V 2G5 • Canada  
**TechInfo Line 1-888-484-8643**  
1-800-387-7373 • Fax (519) 885-0887  
[www.viessmann.ca](http://www.viessmann.ca) • [info@viessmann.ca](mailto:info@viessmann.ca)

Viessmann Manufacturing Company (U.S.) Inc.  
45 Access Road  
Warwick, Rhode Island • 02886 • USA  
**TechInfo Line 1-888-484-8643**  
1-800-288-0667 • Fax (401) 732-0590  
[www.viessmann-us.com](http://www.viessmann-us.com) • [info@viessmann-us.com](mailto:info@viessmann-us.com)